

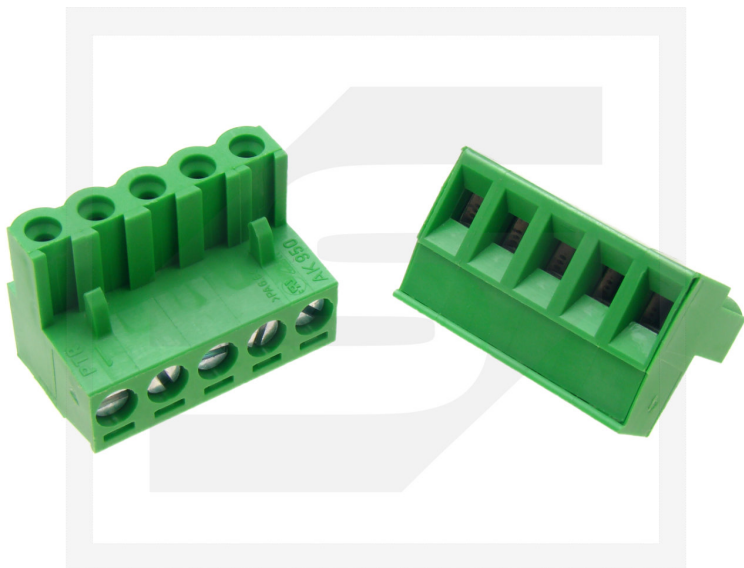

Złącze AK950/5-5.0 5 PIN RoHS PTR MESSTECHNIK



Dane techniczne:

Nazwa: AK950/5-5.0

Liczba pinów: 5

Zacisk: śrubowy, docisk

Przekrój przewodu: max 2.5 mm²

Prąd znamionowy: 12A

Napięcie znamionowe: 250V

Rozstaw: 5mm

Temperatura pracy: -30...105°C

Producent: PTR Messtechnik

Cage Clamp Principle

AK(Z) 950

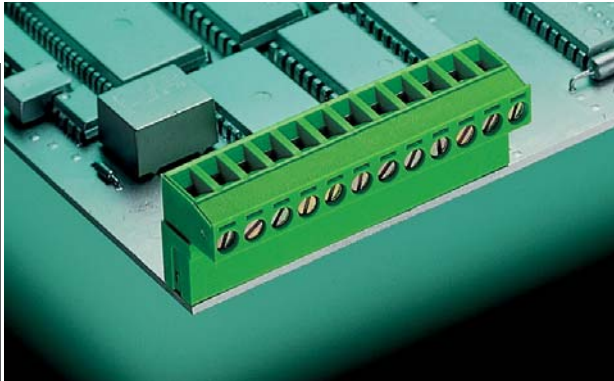

AK(Z) 950/.. - 5.0 (5.08) - GREEN

also available: ..L

2-24 poles, Spacing 5,0 mm or 5,08 mm

insert required no. of poles ..

How to order see page 11

AK(Z) 950



AK(Z) 950/.. F - 5.0 (5.08) - GREEN



also available: ..FL

2-24 poles, Spacing 5,0 mm or 5,08 mm

insert required no. of poles ..

How to order see page 11

Ratings:

		
Rated Voltage	300 V	250 V
Rated Current	15 A	12 A (T60)
Oversoltage Category		III
Wire Size	AWG 22-12	2,5 mm ²
Rating Impulse Voltage/Dirt Level		4 kV/3
Rated Torque / Screw Size		0,5 Nm/M3

Max. Rated Cross Section

Single Wire (solid)	2,5 mm ²
Stranded Wire (flexible)	2,5 mm ²
Stranded wire with Ferrules	2,5 mm ²



Dimensions

Spacing	5,0 mm (5,08 mm)
Stripped Length	6,0 mm

Materials

Insulating Material	PA
Flammability Class	UL94 V-0
Temperature Range	-30°C/+105°C
Terminal Block	CuZn
Contact	CuSn
Colour	green
	RAL 6018

Ratings:

		
Rated Voltage	300 V	250 V
Rated Current	15 A	12 A (T60)
Oversoltage Category		III
Wire Size	AWG 22-12	2,5 mm ²
Rating Impulse Voltage/Dirt Level		4 kV/3
Rated Torque / Screw Size		0,5 Nm/M3

Max. Rated Cross Section

Single Wire (solid)	2,5 mm ²
Stranded Wire (flexible)	2,5 mm ²
Stranded wire with Ferrules	2,5 mm ²

Dimensions

Spacing	5,0 mm (5,08 mm)
Stripped Length	6,0 mm

Materials

Insulating Material	PA
Flammability Class	UL94 V-0
Temperature Range	-30°C/+105°C
Terminal Block	CuZn
Contact	CuSn
Colour	green
	RAL 6018

AK(Z) 950

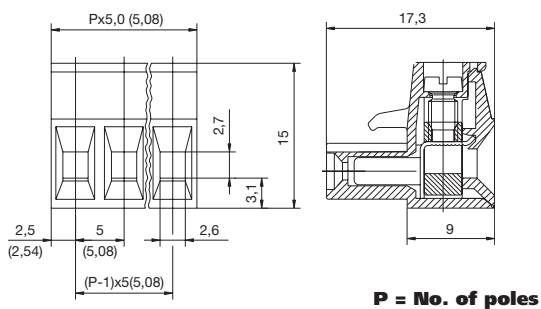

AK(Z) 950 Flange

