

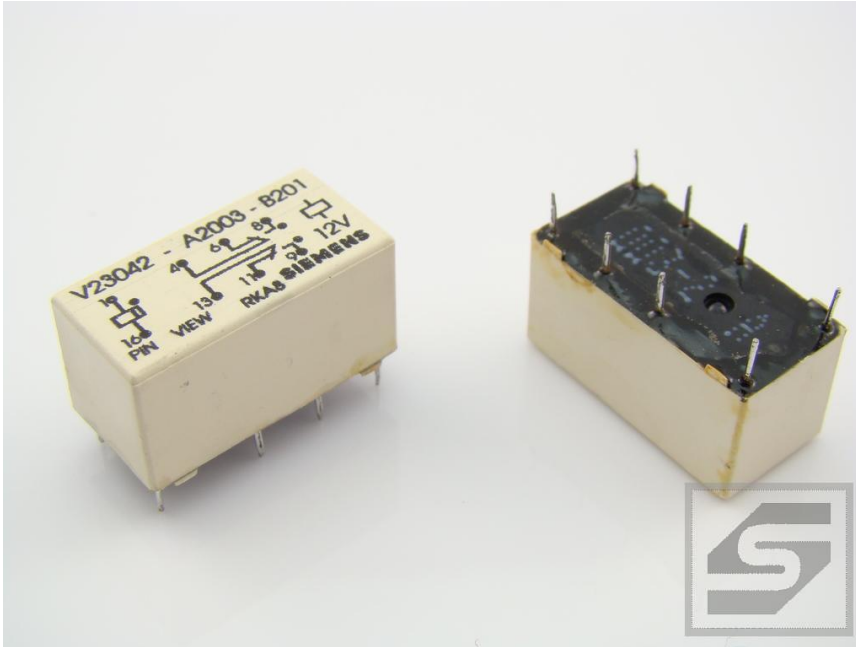

Przełącznik V23042-A2003-B201 12VDC SIEMENS odp.M4-12VDC



Dane techniczne:

Nazwa: V23042-A2003-B201

Konfiguracja styków: 2 pary styków przełącznych(DPDT)

Napięcie cewki: 12VDC

Obciążalność styków: 2A

Producent: SIEMENS

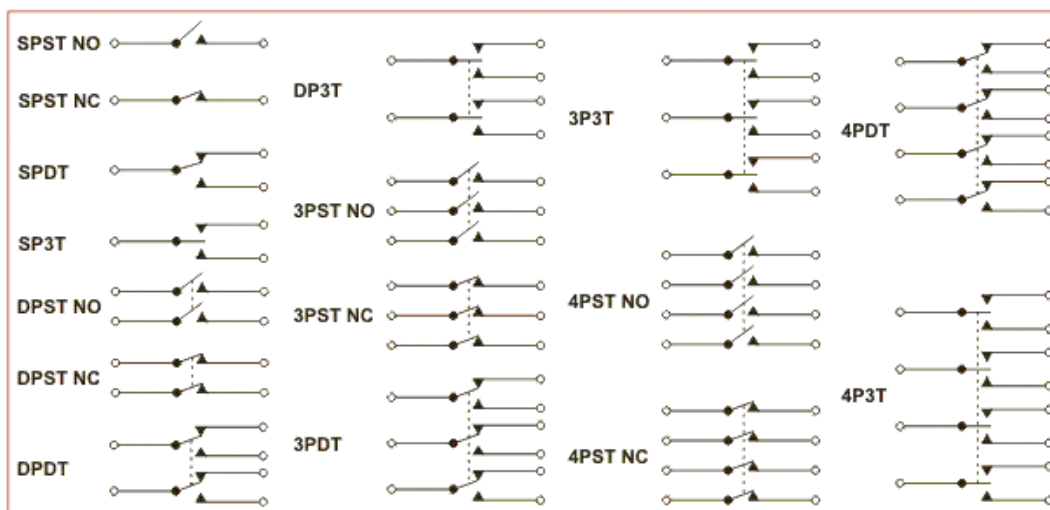

PCB relay for DC voltage, polarized, monostable or bistable

Features

- Universally applicable in the most varied circuit functions in the field of telecommunications and small signal technology
- Versatile design as it can be delivered with different power consumptions ($P_N = 150$ to 250 mW) as well as with reversed coil polarity
- High reliability due to slide-free operation of the middle spring
- High-voltage resistance according to FCC Part 68

Typical applications

- Standard telecommunication relay for public and private networks and terminal equipment
- Interface relay for microcomputer systems
- Storage element for input and output equipment (bistable version)
- Measurement and control
- Automobile technology
- Entertainment electronics
- Signalling systems
- Medical equipment

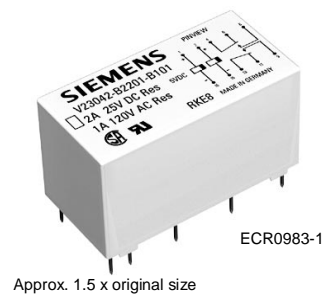

Approx. 1.5 x original size

Versions

- Relay types: monostable with 1 winding or bistable with 2 windings or bistable with 1 winding
- With 2 changeover contacts
- With double contacts
- For printed circuit assembling
- Immersion cleanable

Approvals



UL

File E 48393



CSA

File LR 50227-7

Small relay D2

Dimension drawing (in mm)

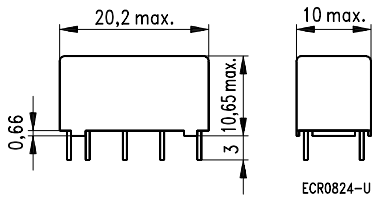

Mounting hole layout

View on the terminals

Monostable and bistable,
1 winding

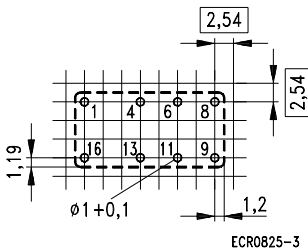

Basic grid 2.54 mm according to EN 60097 and DIN 40803, fine

Bistable,
2 windings

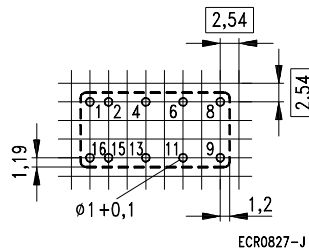

Basic grid 2.54 mm according to EN 60097 and DIN 40803, fine

Terminal assignment

View on the terminals

Monostable and bistable,
1 winding
V23042-A2***
V23042-C2***

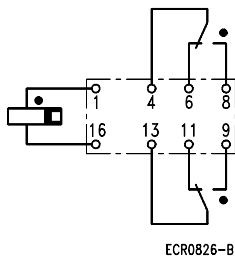

The switch position illustrated shows the release condition. If a positive potential is applied to terminal 1, the relay adopts the operating position.

Monostable and bistable,
1 winding
V23042-A3***
V23042-C3***

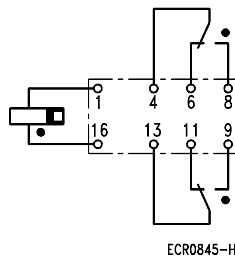

The switch position illustrated shows the release condition. If a positive potential is applied to terminal 16, the relay adopts the operating position.

Bistable,
2 windings
V23042-B2***

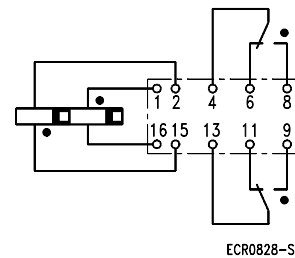

The switch position illustrated shows the release condition. If a positive potential is applied to terminal 1 or 15, the relay adopts the operating position.

Small relay D2

Contact data		
Ordering code block 3	B101	B201
Number of contact and type	2 changeover contacts	
Contact assembly	Double contacts	
Contact material	Gold-plated silver against palladium silver	Gold-plated palladium silver against palladium silver
Max. continuous current at max. ambient temperature	2 A	
Maximum switching current	5 A	
Maximum switching voltage	250 V~ 220 V~	
Maximum switching voltage according to VDE 0110, insulation group A	150 V~ 125 V~	
Maximum switching capacity	50 ... 150 W, see load limit curve	
DC voltage	250 VA	
AC voltage	250 VA	
Recommended for load voltages greater than	100 μ V	
Thermoelectric potential	$\leq 10 \mu$ V	
Contact resistance (initial value) / measuring current / driver voltage	$\leq 50 \text{ m}\Omega / 10 \text{ mA} / 20 \text{ mV}$	

Load limit curve

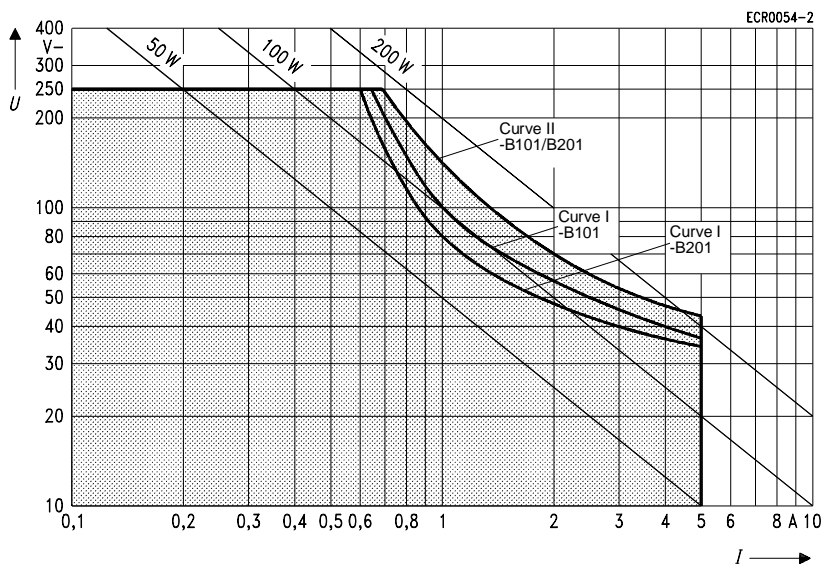

I = switching current

U = switching voltage

■ = recommended application field

Definition of the load limit curve I:

Quenching of the arc before the transit time

Definition of the load limit curve II:

In 1000 operations, no arc with a burning time of $> 10 \text{ ms}$ may occur

Small relay D2

Coil data

Nominal energizing voltage	From 3V– to 48V–
Typical nominal power consumption monostable with 1 winding bistable with 2 windings bistable with 1 winding	150 ... 250 mW 150 ... 200 mW 75 ... 100 mW (depending on the coil version, see table)
Maximum operating voltage	70 ... 80 % of the nominal energizing voltage, depending on the coil version
Maximum reverse voltage (bistable)	75 % of the nominal energizing voltage
Minimum release voltage (monostable)	10 % of the nominal energizing voltage
Maximum holding voltage (non-releasing, monostable)	35 % of the nominal energizing voltage

U_I = minimum voltage at 20 °C after pre-energizing with nominal energizing voltage without contact current

U_{II} = maximum continuous voltage at 20 °C

The operating voltage limits U_I and U_{II} are dependent on the temperature according to the formulae:

$$U_{I \text{ t amb}} = k_I \cdot U_{I \text{ 20 °C}}$$

and

$$U_{II \text{ t amb}} = k_{II} \cdot U_{II \text{ 20 °C}}$$

t_{amb} = ambient temperature

$U_{I \text{ t amb}}$ = minimum voltage at ambient temperature, t_{amb}

$U_{II \text{ t amb}}$ = maximum voltage at ambient temperature, t_{amb}

k_I a. k_{II} = factors (temperature dependent), see diagram

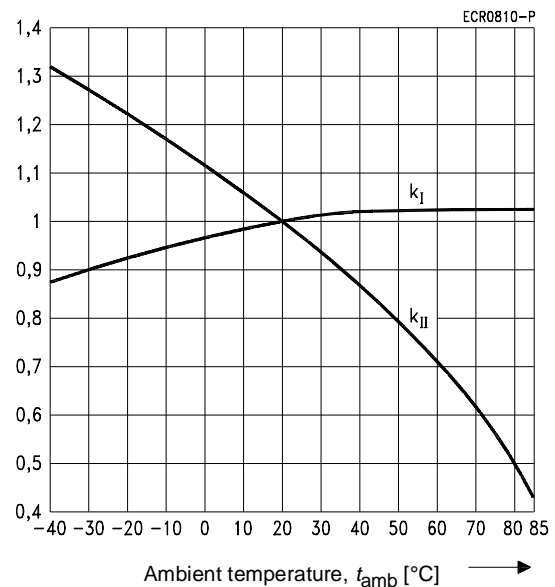

Small relay D2

Coil versions				
Nominal energizing voltage U_{nom}	Operating voltage range at 20 °C		Resistance at 20 °C	Coil number Ordering code block 2
	Minimum voltage, U_{I}	Maximum voltage, U_{II}		
V–	V–	V–	Ω	
monostable, 1 winding, 150 mW nominal power consumption				A2*** / A3***
5	4	12.3	167 ± 16.7	601
12	9.6	29	960 ± 96	603
24	19.2	57	3840 ± 384	605
monostable, 1 winding, 200 mW nominal power consumption				A2*** / A3***
3	2.4	6.4	45 ± 4.5	308
5	4	10.6	125 ± 12.5	301
12	9.6	25.5	720 ± 72	303
24	19.2	50.9	2880 ± 288	305
48	38.4	101.8	11520 ± 1152	307
monostable, 1 winding, 250 mW nominal power consumption				A2*** / A3***
3	2.25	5.7	36 ± 3.6	008
5	3.75	9.2	95 ± 9.5	001
12	9	23.2	600 ± 60	003
24	18	44.6	2210 ± 221	005
48	36	93.7	9750 ± 975	015
bistable, 2 windings, 150 mW nominal power consumption				B2***
3	2.25	7.3	60 ± 6	358
5	3.75	12.3	167 ± 16.7	351
12	9	29.4	960 ± 96	353
24	18	58.8	3840 ± 384	355
bistable, 2 windings, 200 mW nominal power consumption				B2***
3	2.25	6.4	45 ± 4.5	208
5	3.75	10.6	125 ± 12.5	201
12	9	25.5	720 ± 72	203
24	18	42.8	2040 ± 204	205
bistable, 1 winding, 75 mW nominal power consumption				C2*** / C3***
3	2.25	10.4	120 ± 12	158
5	3.75	17.2	330 ± 33	151
12	9	6.4	1920 ± 192	153
24	18	83.1	7680 ± 768	155
bistable, 1 winding, 100 mW nominal power consumption				C2*** / C3***
3	2.25	9	90 ± 9	108
5	3.75	15	250 ± 25	101
12	9	36	1440 ± 144	103
24	18	60	4000 ± 400	105

Further coil versions are available on request.

Small relay D2

General data

Typical operate time at U_{nom} and at 20 °C	3 ms
Typical reverse time at U_{nom} and at 20 °C	3 ms
Typical release time without/with diode in parallel	2 ms / 4 ms
Typical bounce time	3 ms
Maximum switching rate without load	100 operations/s
Ambient temperature according to DIN IEC 255 Part 1-00 or VDE 0435 part 201	-40 °C ... +85 °C
Vibration resistance, Frequency range according to IEC 68-2-6	50 g 10 - 500 Hz
Shock resistance, half sinus, 11 ms according to IEC 68-2-27	50 g
Protection class according to DIN VDE 0470 part 1 / IEC 529	immersion cleanable sealing corresponds to DIN IEC 68, part 2-17, method Qc 2
Mechanical endurance	2×10^7 switching cycles
Mounting position	any
Processing information	Ultrasonic cleaning is not recommended
Weight	approx. 5 g

Electrical endurance

Contact material silver, gold-plated, against palladium silver (-B101)

Switching voltage V	Switching current mA	Switching cycles	Load type	Endurance determined by switching cycles
0	0	approx. 2×10^7	dry circuit	10
6–	100	approx. 2×10^7	resistive	10
24–	50	approx. 2×10^7	resistive	10

Contact material palladium silver, gold-plated, against palladium silver (-B201)

Switching voltage V	Switching current mA	Switching cycles	Load type	Endurance determined by switching cycles
0	0	approx. 2×10^7	dry circuit	10
6–	100	approx. 2×10^7	resistive	10
24–	50	approx. 2×10^7	resistive	10
60–	50	approx. 10^7	resistive with 10 m cable	10

Insulation

Insulation's resistance at 500 V	1000 MΩ
Dielectric test voltage (1 min) Contact / winding at 1 winding / at 2 windings Changeover contact / changeover contact Changeover tip / changeover tip	1500 V _{~eff} / 1000 V _{~eff} 1500 V _{~eff} 1000 V _{~eff}

Small relay D2

Ordering code

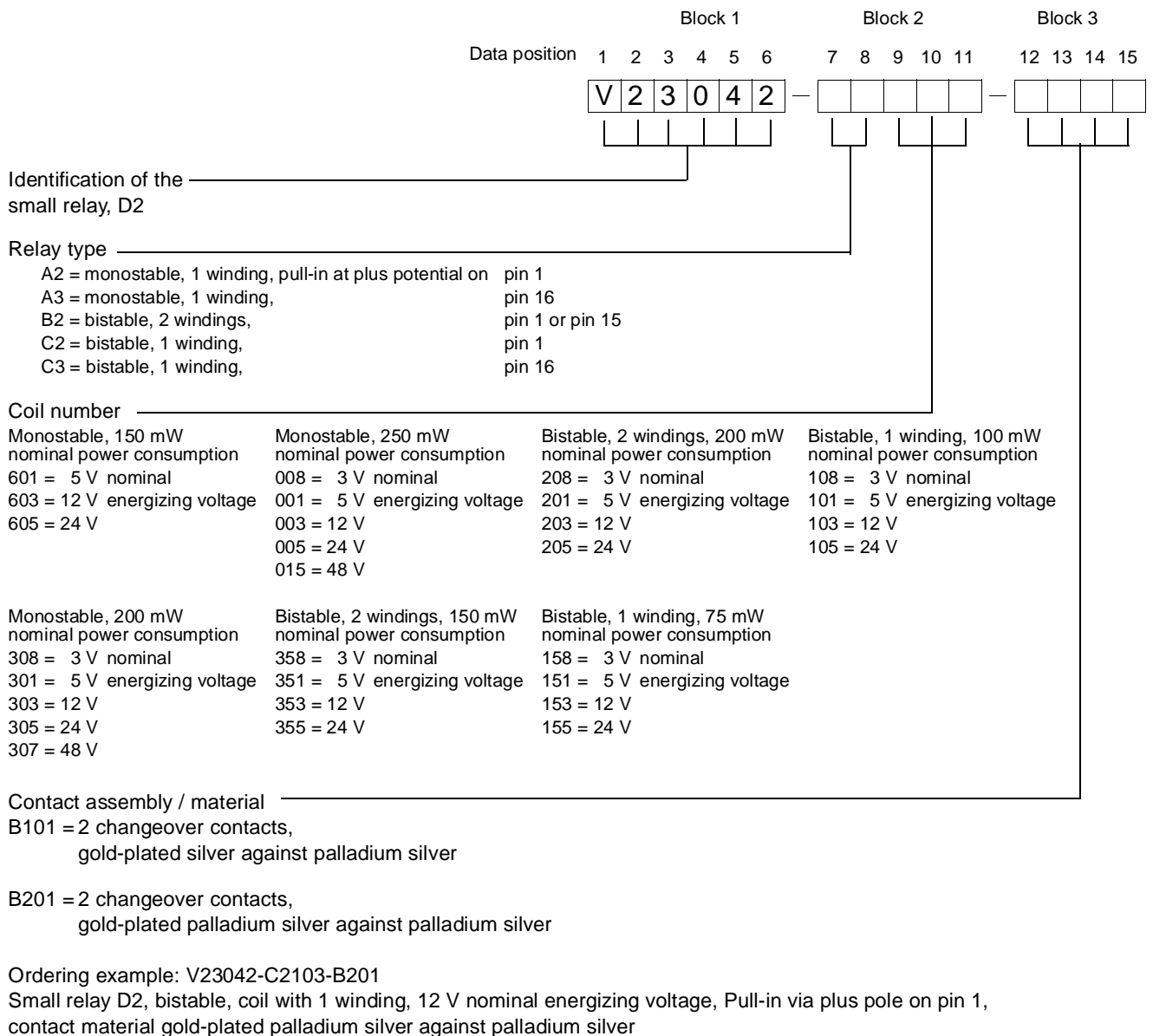

Note:

The ordering scheme above covers far more possible varieties than are presently offered in the delivery program. Special designs to customer specifications are possible; please contact your local office.

Preferred standard types (delivery program)

V23042 -A2001-B101	V23042 -B2201-B101	V23042 -C2101-B101
-A2001-B201	-B2203-B101	-C2103-B101
-A2003-B101	-B2205-B101	
-A2003-B201		
-A2005-B101		
-A2005-B201		