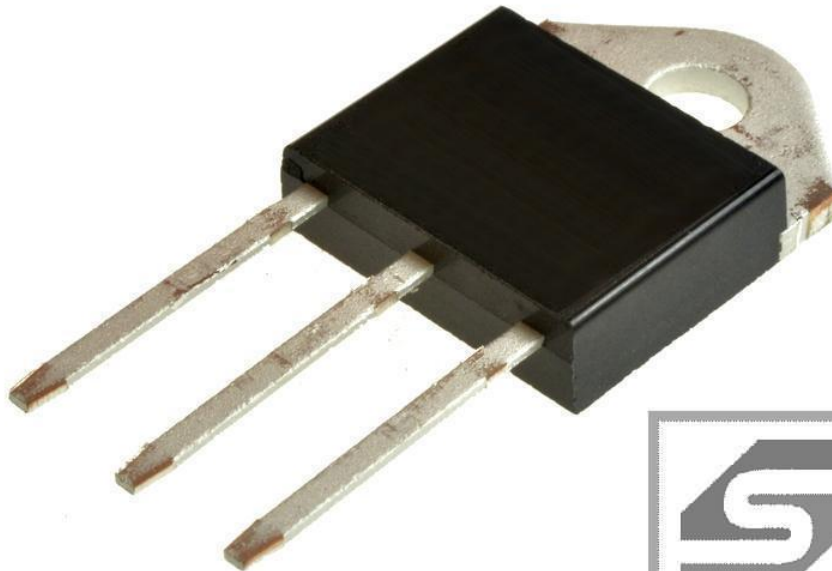




# Triak BTA41-600BRG;ST;40A;600V;50mA TO3P;przewlekany THT;izolowany;RoHS



## Dane techniczne:

Nazwa: BTA41-600BRG  
Typ: Triak  
Prąd przewodzenia: 40A  
Napięcie wsteczne: 600V  
Prąd bramki: 50mA  
Obudowa: TO3P  
Montaż: THT  
Producent: ST



# BTA40 and BTA/BTB41 Series

STANDARD

40A TRIACs

## MAIN FEATURES:

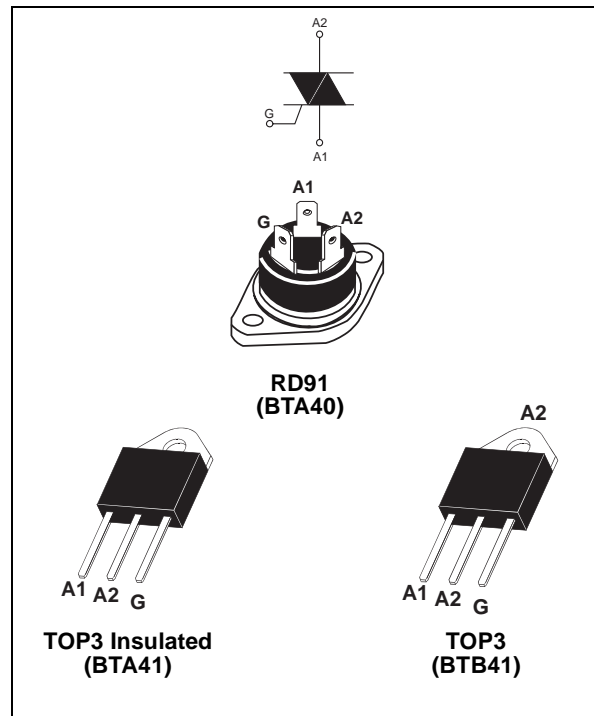
Symbol	Value	Unit
$I_{T(RMS)}$	40	A
$V_{DRM}/V_{RRM}$	600 and 800	V
$I_{GT}(Q_1)$	50	mA

## DESCRIPTION

Available in high power packages, the BTA/BTB40-41 series is suitable for general purpose AC power switching. They can be used as an ON/OFF function in applications such as static relays, heating regulation, water heaters, induction motor starting circuits, welding equipment... or for phase control operation in high power motor speed controllers, soft start circuits...

Thanks to their clip assembly technique, they provide a superior performance in surge current handling capabilities.

By using an internal ceramic pad, the BTA series provides voltage insulated tab (rated at 2500 V RMS) complying with UL standards (File ref.: E81734).



## ABSOLUTE MAXIMUM RATINGS

Symbol	Parameter		Value	Unit	
$I_{T(RMS)}$	RMS on-state current (full sine wave)	RD91	40	A	
		TOP3			
		TOP3 Ins.	$T_c = 70^\circ\text{C}$		
$I_{TSM}$	Non repetitive surge peak on-state current (full cycle, $T_j$ initial = $25^\circ\text{C}$ )	F = 60 Hz	t = 16.7 ms	420	A
		F = 50 Hz	t = 20 ms	400	
$I^2t$	$I^2t$ Value for fusing	tp = 10 ms		880	$\text{A}^2\text{s}$
dI/dt	Critical rate of rise of on-state current $I_G = 2 \times I_{GT}$ , $t_r \leq 100$ ns	F = 120 Hz	$T_j = 125^\circ\text{C}$	50	A/ $\mu\text{s}$
$V_{DSM}/V_{RSM}$	Non repetitive surge peak off-state voltage	tp = 10 ms	$T_j = 25^\circ\text{C}$	$V_{DRM}/V_{RRM} + 100$	V
$I_{GM}$	Peak gate current	tp = 20 $\mu\text{s}$	$T_j = 125^\circ\text{C}$	8	A
$P_{G(AV)}$	Average gate power dissipation	$T_j = 125^\circ\text{C}$		1	W
$T_{stg}$ $T_j$	Storage junction temperature range Operating junction temperature range			- 40 to + 150 - 40 to + 125	$^\circ\text{C}$

## BTA40 and BTA/BTB41 Series

### ELECTRICAL CHARACTERISTICS (T<sub>j</sub> = 25°C, unless otherwise specified)

Symbol	Test Conditions	Quadrant		Value	Unit
I <sub>GT</sub> (1)	V <sub>D</sub> = 12 V    R <sub>L</sub> = 33 Ω	I - II - III IV	MAX.	50 100	mA
V <sub>GT</sub>		ALL	MAX.	1.3	V
V <sub>GD</sub>	V <sub>D</sub> = V <sub>DRM</sub> R <sub>L</sub> = 3.3 kΩ    T <sub>j</sub> = 125°C	ALL	MIN.	0.2	V
I <sub>H</sub> (2)	I <sub>T</sub> = 500 mA		MAX.	80	mA
I <sub>L</sub>	I <sub>G</sub> = 1.2 I <sub>GT</sub>	I - III - IV	MAX.	70	mA
		II		160	
dV/dt (2)	V <sub>D</sub> = 67 % V <sub>DRM</sub> gate open    T <sub>j</sub> = 125°C		MIN.	500	V/μs
(dV/dt) <sub>c</sub> (2)	(dI/dt) <sub>c</sub> = 20 A/ms    T <sub>j</sub> = 125°C		MIN.	10	V/μs

### STATIC CHARACTERISTICS

Symbol	Test Conditions		Value	Unit	
V <sub>TM</sub> (2)	I <sub>TM</sub> = 60 A    t <sub>p</sub> = 380 μs	T <sub>j</sub> = 25°C	MAX.	1.55	V
V <sub>to</sub> (2)	Threshold voltage	T <sub>j</sub> = 125°C	MAX.	0.85	V
R <sub>d</sub> (2)	Dynamic resistance	T <sub>j</sub> = 125°C	MAX.	10	mΩ
I <sub>DRM</sub>	V <sub>DRM</sub> = V <sub>RRM</sub>	T <sub>j</sub> = 25°C	MAX.	5	μA
I <sub>RRM</sub>		T <sub>j</sub> = 125°C		5	mA

**Note 1:** minimum I<sub>GT</sub> is guaranteed at 5% of I<sub>GT</sub> max.

**Note 2:** for both polarities of A2 referenced to A1

### THERMAL RESISTANCES

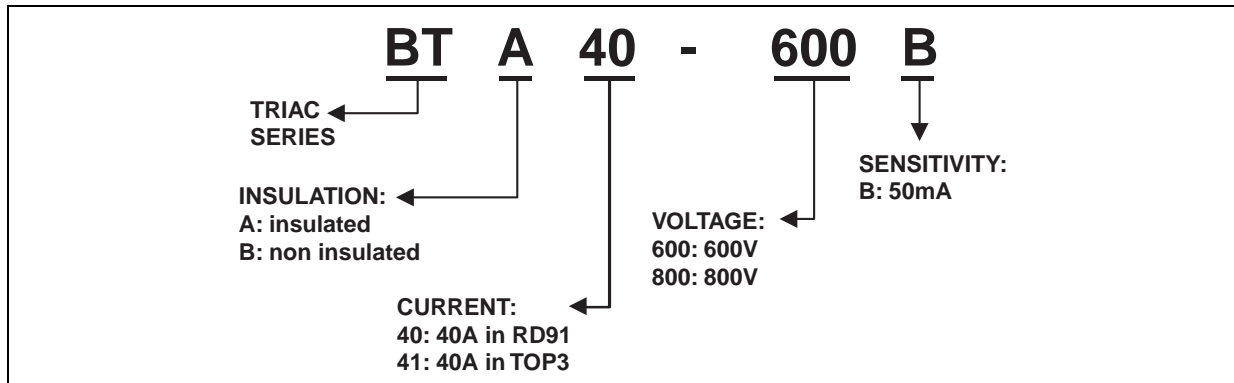
Symbol	Parameter		Value	Unit
R <sub>th(j-c)</sub>	Junction to case (AC)	RD91 (Insulated) TOP3	0.9	°C/W
		TOP3 Insulated	1.2	
R <sub>th(j-a)</sub>	Junction to ambient	TOP3	50	°C/W
		TOP3 Insulated		

### PRODUCT SELECTOR

Part Number	Voltage (xxx)		Sensitivity	Type	Package
	600 V	800 V			
BTA40-xxxB	X	X	50 mA	Standard	RD91
BTA/BTB41-xxxB	X	X	50 mA	Standard	TOP3

BTB: Non insulated TOP3 package

ORDERING INFORMATION



OTHER INFORMATION

Part Number	Marking	Weight	Base quantity	Packing mode
BTA40-xxxB	BTA40xxxB	20.0 g	25	Bulk
BTA/BTB41-xxxB	BTA/BTB41xxxB	4.5 g	120	Bulk

Note: xxx= voltage

Fig. 1: Maximum power dissipation versus RMS on-state current (full cycle).

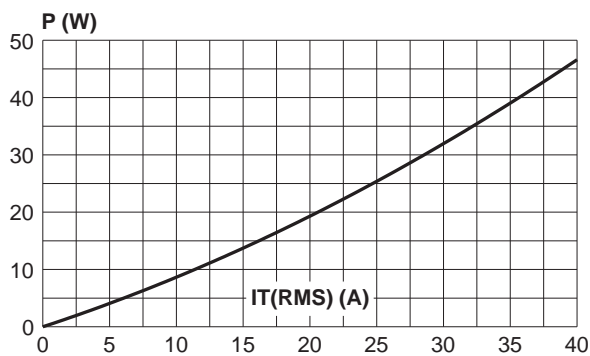
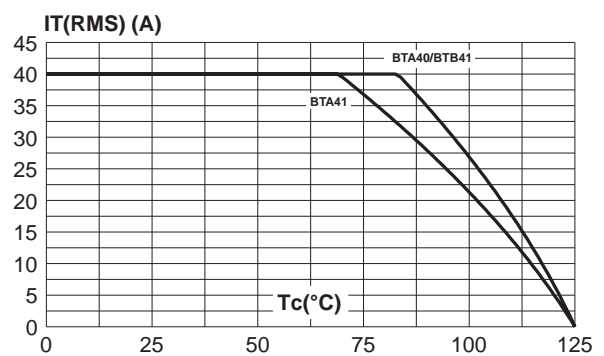
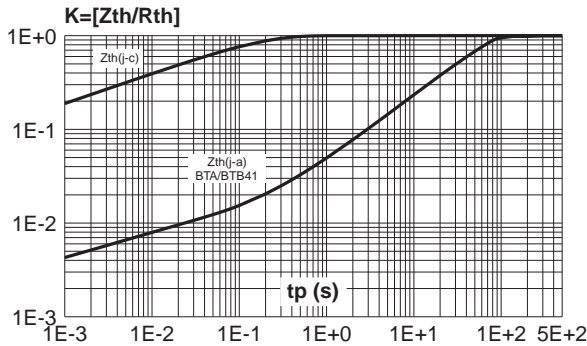


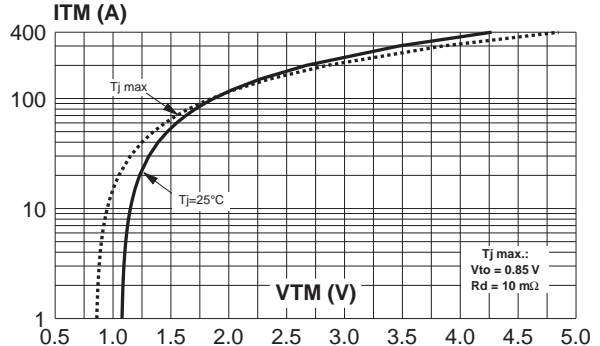
Fig. 2: RMS on-state current versus case temperature (full cycle).



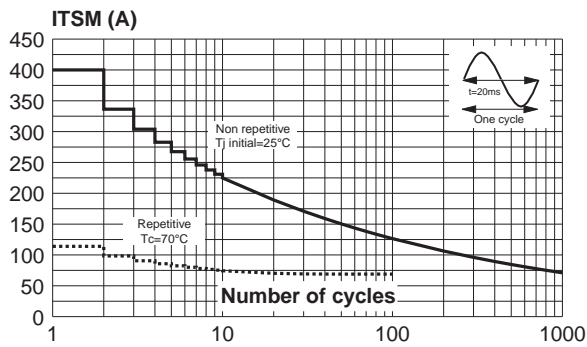
**Fig. 3:** Relative variation of thermal impedance versus pulse duration.



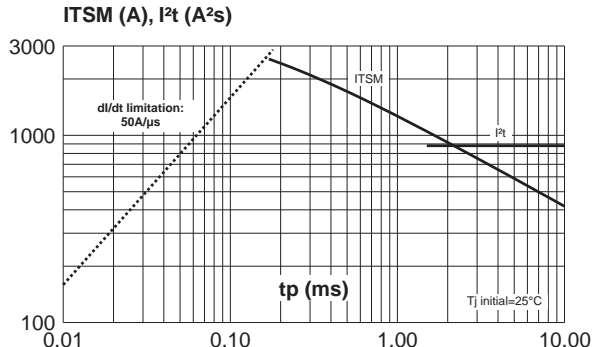
**Fig. 4:** On-state characteristics (maximum values).



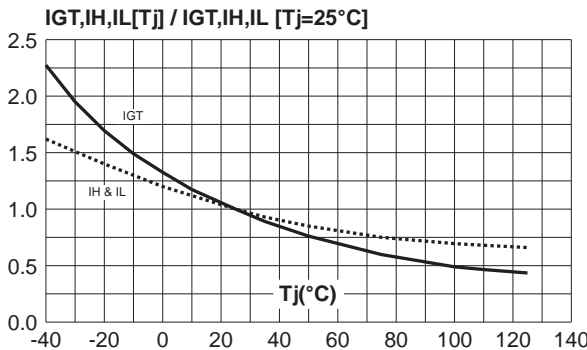
**Fig. 5:** Surge peak on-state current versus number of cycles.



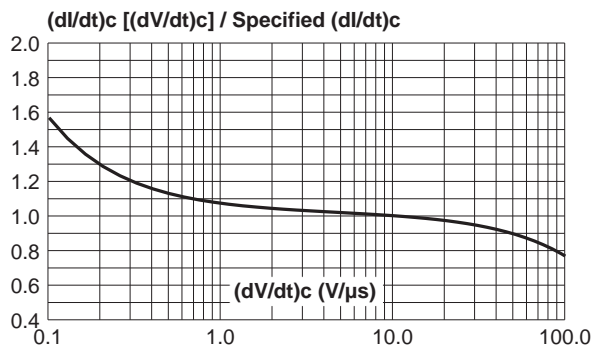
**Fig. 6:** Non-repetitive surge peak on-state current for a sinusoidal pulse with width  $t_p < 10$  ms, and corresponding value of  $I^2t$ .



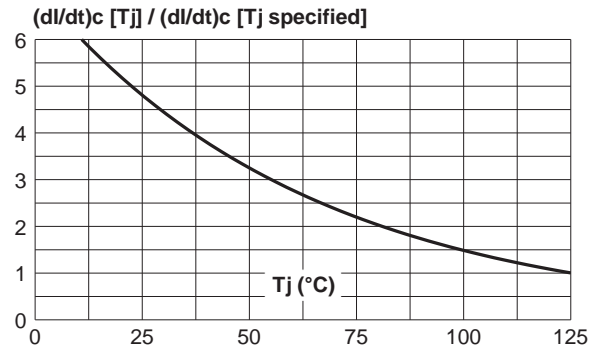
**Fig. 7:** Relative variation of gate trigger current, holding current and latching current versus junction temperature (typical values).



**Fig. 8:** Relative variation of critical rate of decrease of main current versus  $(dV/dt)_c$  (typical values).

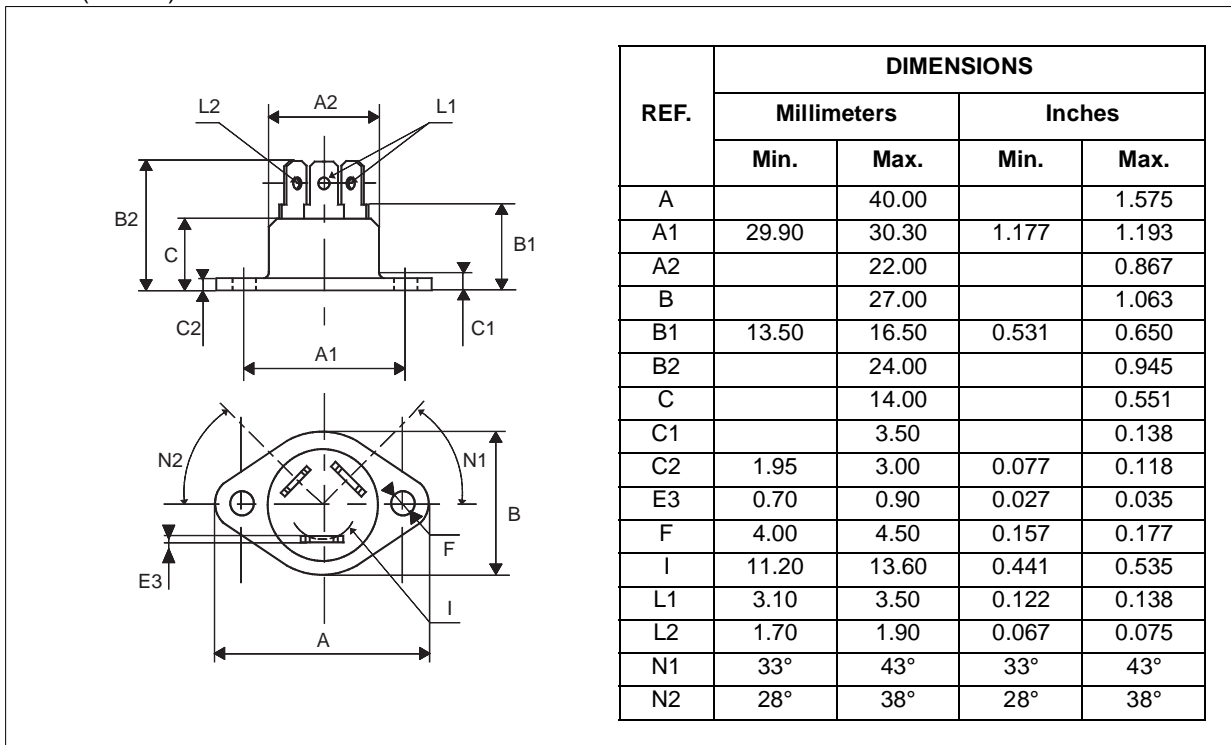


**Fig. 9:** Relative variation of critical rate of decrease of main current versus junction temperature.



**PACKAGE MECHANICAL DATA**

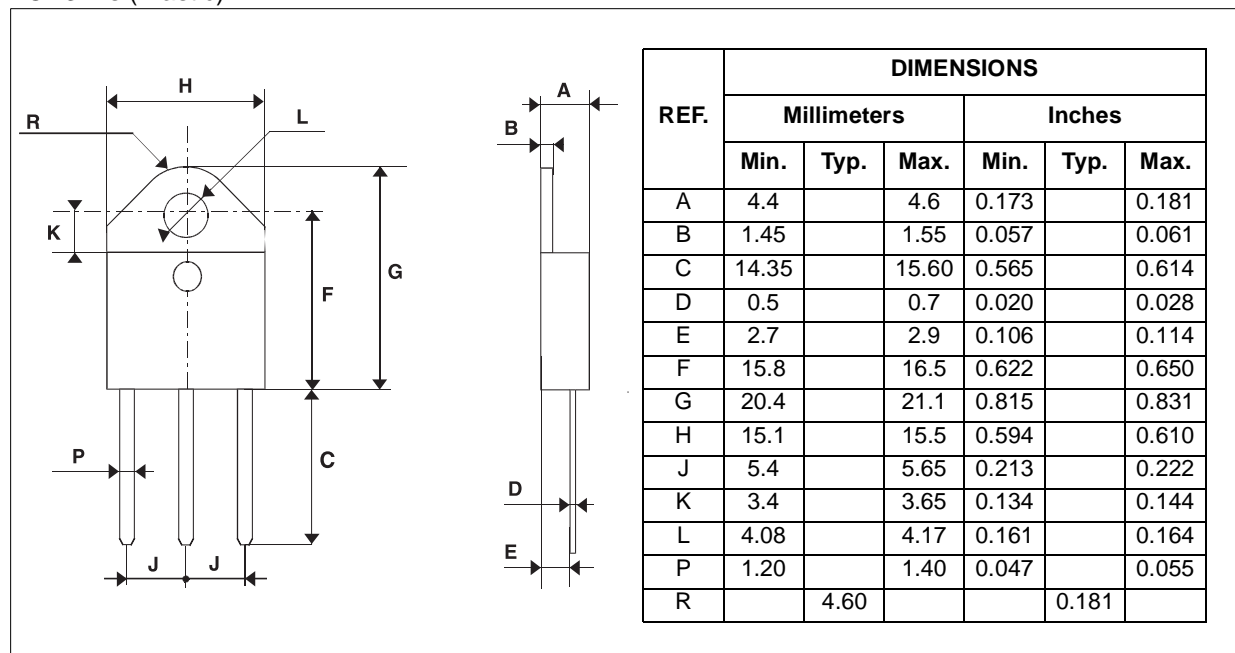
RD91 (Plastic)



## BTA40 and BTA/BTB41 Series

### PACKAGE MECHANICAL DATA

TOP3 Ins.(Plastic)



Information furnished is believed to be accurate and reliable. However, STMicroelectronics assumes no responsibility for the consequences of use of such information nor for any infringement of patents or other rights of third parties which may result from its use. No license is granted by implication or otherwise under any patent or patent rights of STMicroelectronics. Specifications mentioned in this publication are subject to change without notice. This publication supersedes and replaces all information previously supplied. STMicroelectronics products are not authorized for use as critical components in life support devices or systems without express written approval of STMicroelectronics.

© The ST logo is a registered trademark of STMicroelectronics

© 2001 STMicroelectronics - Printed in Italy - All Rights Reserved

STMicroelectronics GROUP OF COMPANIES

Australia - Brazil - China - Finland - France - Germany - Hong Kong - India - Italy - Japan - Malaysia  
Malta - Morocco - Singapore - Spain - Sweden - Switzerland - United Kingdom - U.S.A

<http://www.st.com>

This datasheet has been download from:

[www.datasheetcatalog.com](http://www.datasheetcatalog.com)

Datasheets for electronics components.