

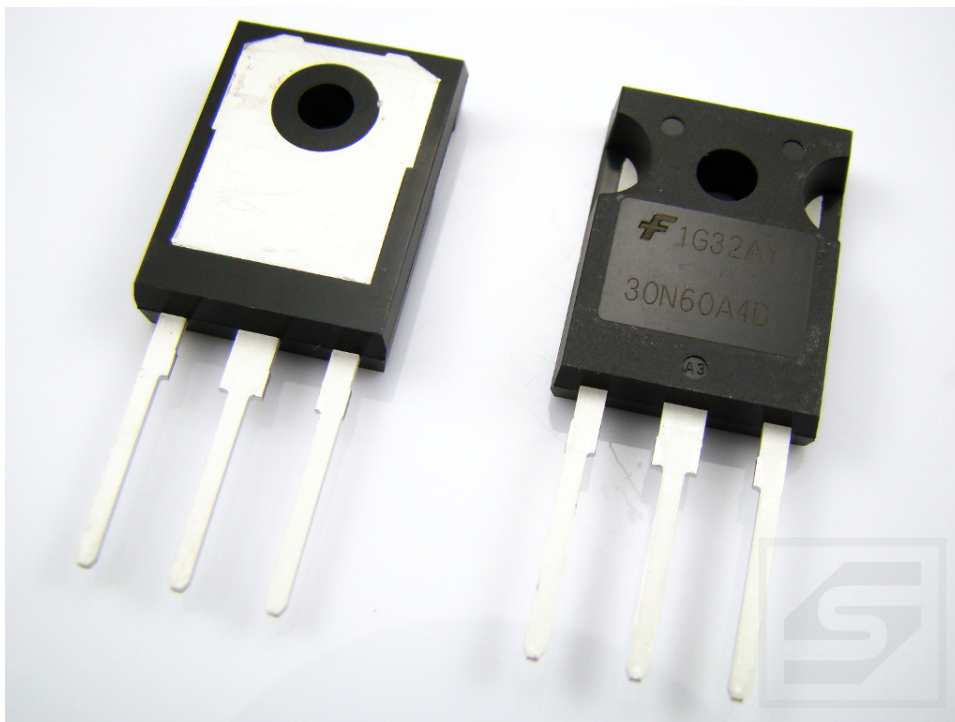

HGTG30N60A4D;FSC;TO247; Tranzystor IGBT;75A;600V;463W;RoHS



Dane techniczne:

Nazwa: HGTG30N60A4D

Typ: tranzystor IGBT

Napięcie kolektor-emiter: 600V

Prąd kolektora: 75A

Moc rozpraszana: 463W

Obudowa: TO247

Montaż: THT

Producent: FSC

600V, SMPS Series N-Channel IGBT with Anti-Parallel Hyperfast Diode

The HGTG30N60A4D is a MOS gated high voltage switching devices combining the best features of MOSFETs and bipolar transistors. This device has the high input impedance of a MOSFET and the low on-state conduction loss of a bipolar transistor. The much lower on-state voltage drop varies only moderately between 25°C and 150°C. The IGBT used is the development type TA49343. The diode used in anti-parallel is the development type TA49373.

This IGBT is ideal for many high voltage switching applications operating at high frequencies where low conduction losses are essential. This device has been optimized for high frequency switch mode power supplies.

Formerly Developmental Type TA49345.

Ordering Information

PART NUMBER	PACKAGE	BRAND
HGTG30N60A4D	TO-247	30N60A4D

NOTE: When ordering, use the entire part number.

Symbol

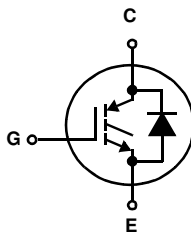

Features

- >100kHz Operation At 390V, 30A
- 200kHz Operation At 390V, 18A
- 600V Switching SOA Capability
- Typical Fall Time. 60ns at T_J = 125°C
- Low Conduction Loss
- *Temperature Compensating SABER™* Model
www.fairchildsemi.com

Packaging

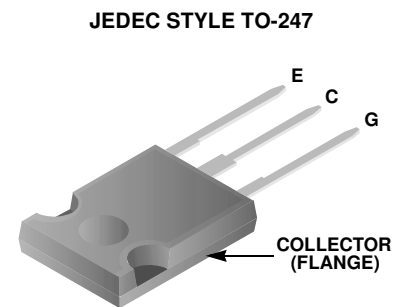

HGTG30N60A4D

Absolute Maximum Ratings $T_C = 25^{\circ}\text{C}$, Unless Otherwise Specified

	HGTG30N60A4D,	UNITS
Collector to Emitter Voltage	BV_{CES}	600 V
Collector Current Continuous		
At $T_C = 25^{\circ}\text{C}$	I_{C25}	75 A
At $T_C = 110^{\circ}\text{C}$	I_{C110}	60 A
Collector Current Pulsed (Note 1)	I_{CM}	240 A
Gate to Emitter Voltage Continuous	V_{GES}	± 20 V
Gate to Emitter Voltage Pulsed	V_{GEM}	± 30 V
Switching Safe Operating Area at $T_J = 150^{\circ}\text{C}$ (Figure 2)	SSOA	150A at 600V
Power Dissipation Total at $T_C = 25^{\circ}\text{C}$	P_D	463 W
Power Dissipation Derating $T_C > 25^{\circ}\text{C}$		3.7 W/ $^{\circ}\text{C}$
Operating and Storage Junction Temperature Range	T_J, T_{STG}	-55 to 150 $^{\circ}\text{C}$
Maximum Temperature for Soldering	T_L	260 $^{\circ}\text{C}$

CAUTION: Stresses above those listed in "Absolute Maximum Ratings" may cause permanent damage to the device. This is a stress only rating and operation of the device at these or any other conditions above those indicated in the operational sections of this specification is not implied.

NOTE:

1. Pulse width limited by maximum junction temperature.

Electrical Specifications $T_J = 25^{\circ}\text{C}$, Unless Otherwise Specified

PARAMETER	SYMBOL	TEST CONDITIONS	MIN	TYP	MAX	UNITS	
Collector to Emitter Breakdown Voltage	BV_{CES}	$I_C = 250\mu\text{A}, V_{GE} = 0\text{V}$	600	-	-	V	
Collector to Emitter Leakage Current	I_{CES}	$V_{CE} = 600\text{V}$	$T_J = 25^{\circ}\text{C}$	-	-	250	μA
			$T_J = 125^{\circ}\text{C}$	-	-	2.8	mA
Collector to Emitter Saturation Voltage	$V_{CE(SAT)}$	$I_C = 30\text{A}, V_{GE} = 15\text{V}$	$T_J = 25^{\circ}\text{C}$	-	1.8	2.6	V
			$T_J = 125^{\circ}\text{C}$	-	1.6	2.0	V
Gate to Emitter Threshold Voltage	$V_{GE(TH)}$	$I_C = 250\mu\text{A}, V_{CE} = V_{GE}$	4.5	5.2	7.0	V	
Gate to Emitter Leakage Current	I_{GES}	$V_{GE} = \pm 20\text{V}$	-	-	± 250	nA	
Switching SOA	SSOA	$T_J = 150^{\circ}\text{C}, R_G = 3\Omega, V_{GE} = 15\text{V}, L = 100\mu\text{H}, V_{CE} = 600\text{V}$	150	-	-	A	
Gate to Emitter Plateau Voltage	V_{GEP}	$I_C = 30\text{A}, V_{CE} = 300\text{V}$	-	8.5	-	V	
On-State Gate Charge	$Q_{g(ON)}$	$I_C = 30\text{A}, V_{CE} = 300\text{V}$	$V_{GE} = 15\text{V}$	-	225	270	nC
			$V_{GE} = 20\text{V}$	-	300	360	nC
Current Turn-On Delay Time	$t_{d(ON)I}$	IGBT and Diode at $T_J = 25^{\circ}\text{C}$, $I_{CE} = 30\text{A}, V_{CE} = 390\text{V}, V_{GE} = 15\text{V}, R_G = 3\Omega, L = 200\mu\text{H}$, Test Circuit (Figure 24)	-	25	-	ns	
Current Rise Time	t_{rI}		-	12	-	ns	
Current Turn-Off Delay Time	$t_{d(OFF)I}$		-	150	-	ns	
Current Fall Time	t_{fI}		-	38	-	ns	
Turn-On Energy (Note 2)	E_{ON1}		-	280	-	μJ	
Turn-On Energy (Note 2)	E_{ON2}		-	600	-	μJ	
Turn-Off Energy (Note 3)	E_{OFF}		-	240	350	μJ	
Current Turn-On Delay Time	$t_{d(ON)I}$	IGBT and Diode at $T_J = 125^{\circ}\text{C}$, $I_{CE} = 30\text{A}, V_{CE} = 390\text{V}, V_{GE} = 15\text{V}, R_G = 3\Omega, L = 200\mu\text{H}$, Test Circuit (Figure 24)	-	24	-	ns	
Current Rise Time	t_{rI}		-	11	-	ns	
Current Turn-Off Delay Time	$t_{d(OFF)I}$		-	180	200	ns	
Current Fall Time	t_{fI}		-	58	70	ns	
Turn-On Energy (Note 2)	E_{ON1}		-	280	-	μJ	
Turn-On Energy (Note 2)	E_{ON2}		-	1000	1200	μJ	
Turn-Off Energy (Note 3)	E_{OFF}		-	450	750	μJ	
Diode Forward Voltage	V_{EC}	$I_{EC} = 30\text{A}$	-	2.2	2.5	V	
Diode Reverse Recovery Time	t_{rr}	$I_{EC} = 30\text{A}, dI_{EC}/dt = 200\text{A}/\mu\text{s}$	-	40	55	ns	
		$I_{EC} = 1\text{A}, dI_{EC}/dt = 200\text{A}/\mu\text{s}$	-	30	42	ns	

HGTG30N60A4D

Electrical Specifications $T_J = 25^\circ\text{C}$, Unless Otherwise Specified (Continued)

PARAMETER	SYMBOL	TEST CONDITIONS	MIN	TYP	MAX	UNITS
Thermal Resistance Junction To Case	$R_{\theta JC}$	IGBT	-	-	0.27	$^\circ\text{C/W}$
		Diode	-	-	0.65	$^\circ\text{C/W}$

NOTES:

- Values for two Turn-On loss conditions are shown for the convenience of the circuit designer. E_{ON1} is the turn-on loss of the IGBT only. E_{ON2} is the turn-on loss when a typical diode is used in the test circuit and the diode is at the same T_J as the IGBT. The diode type is specified in Figure 24.
- Turn-Off Energy Loss (E_{OFF}) is defined as the integral of the instantaneous power loss starting at the trailing edge of the input pulse and ending at the point where the collector current equals zero ($I_{CE} = 0\text{A}$). All devices were tested per JEDEC Standard No. 24-1 Method for Measurement of Power Device Turn-Off Switching Loss. This test method produces the true total Turn-Off Energy Loss.

Typical Performance Curves Unless Otherwise Specified

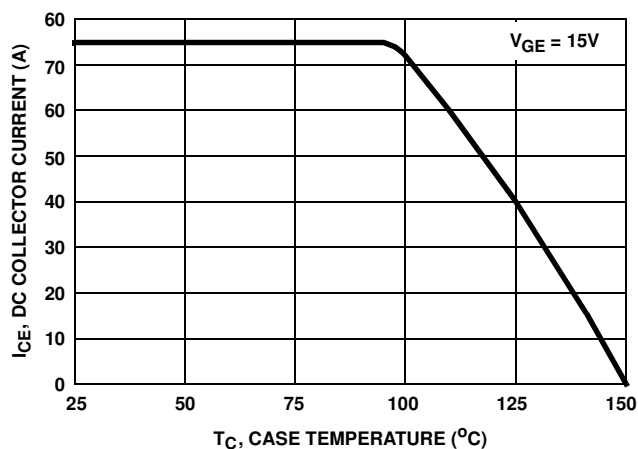

FIGURE 1. DC COLLECTOR CURRENT vs CASE TEMPERATURE

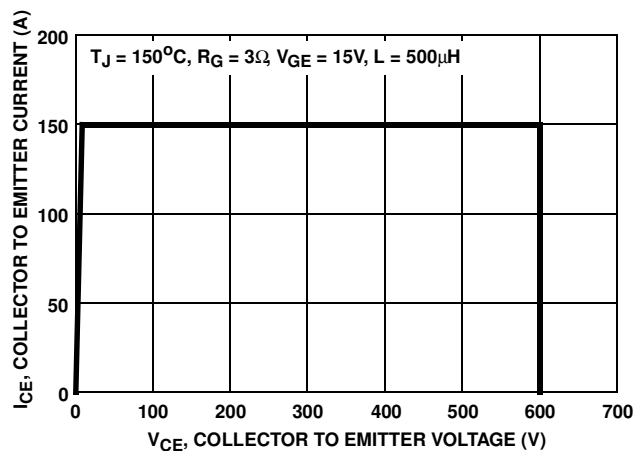

FIGURE 2. MINIMUM SWITCHING SAFE OPERATING AREA

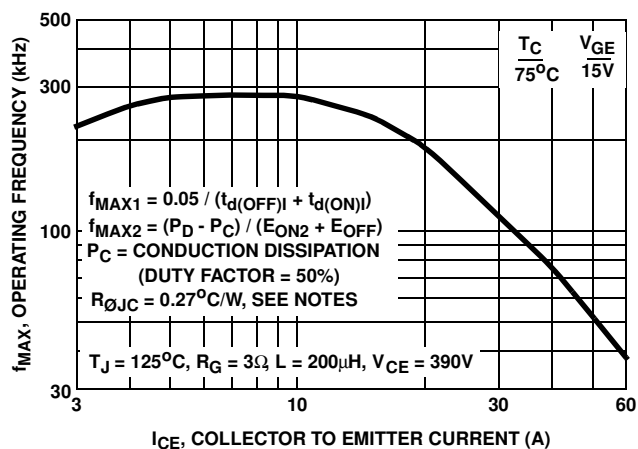

FIGURE 3. OPERATING FREQUENCY vs COLLECTOR TO EMITTER CURRENT

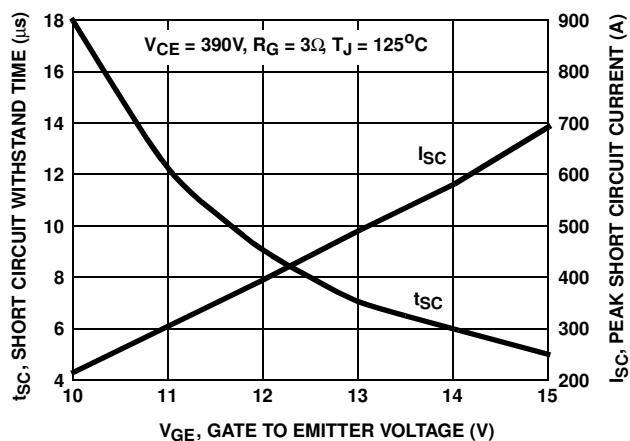

FIGURE 4. SHORT CIRCUIT WITHSTAND TIME

Typical Performance Curves Unless Otherwise Specified (Continued)

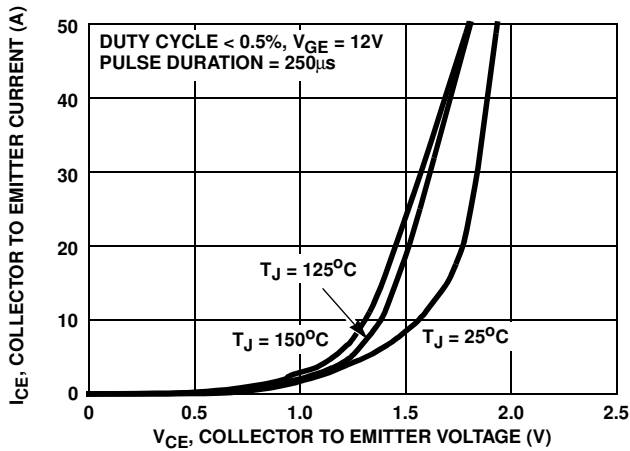

FIGURE 5. COLLECTOR TO EMITTER ON-STATE VOLTAGE

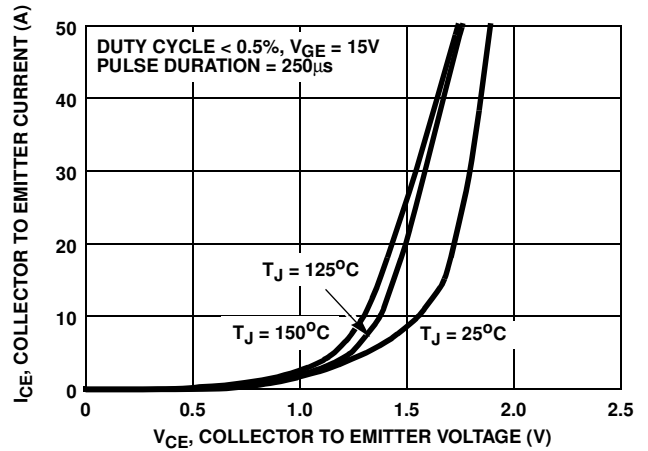

FIGURE 6. COLLECTOR TO EMITTER ON-STATE VOLTAGE

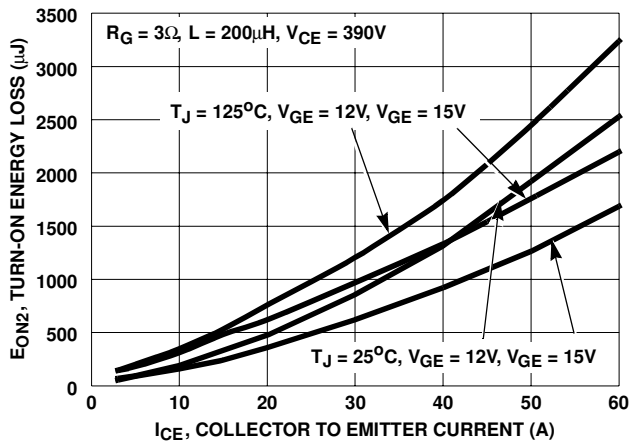

FIGURE 7. TURN-ON ENERGY LOSS vs COLLECTOR TO EMITTER CURRENT

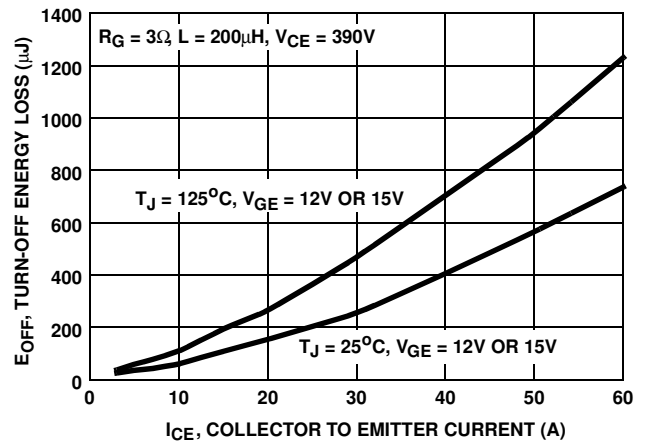

FIGURE 8. TURN-OFF ENERGY LOSS vs COLLECTOR TO EMITTER CURRENT

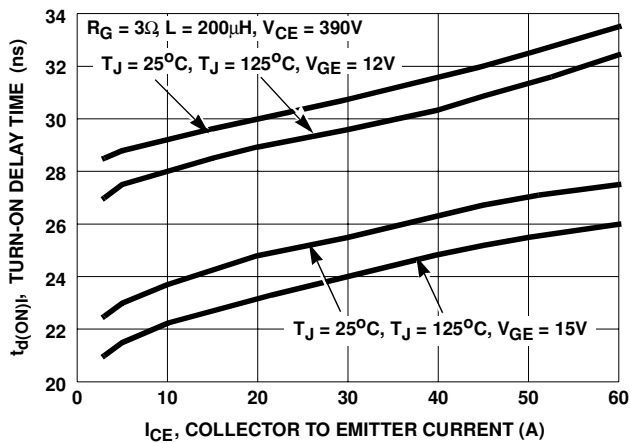

FIGURE 9. TURN-ON DELAY TIME vs COLLECTOR TO EMITTER CURRENT

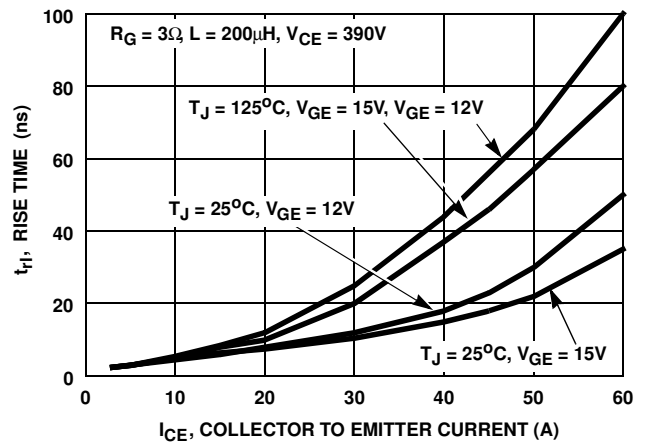

FIGURE 10. TURN-ON RISE TIME vs COLLECTOR TO EMITTER CURRENT

Typical Performance Curves Unless Otherwise Specified (Continued)

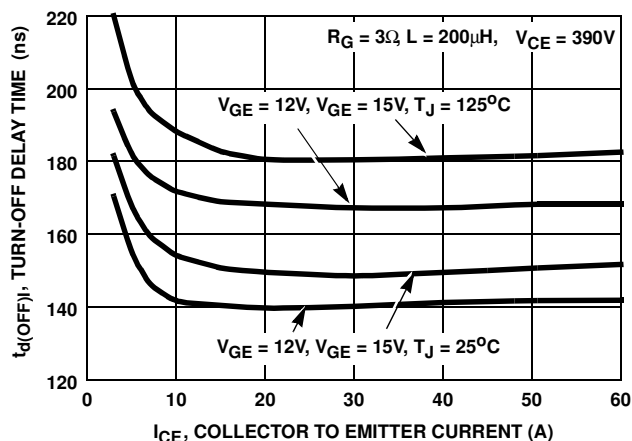

FIGURE 11. TURN-OFF DELAY TIME vs COLLECTOR TO EMITTER CURRENT

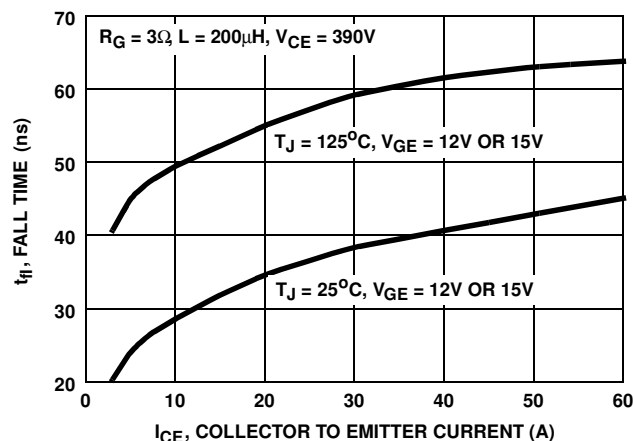

FIGURE 12. FALL TIME vs COLLECTOR TO EMITTER CURRENT

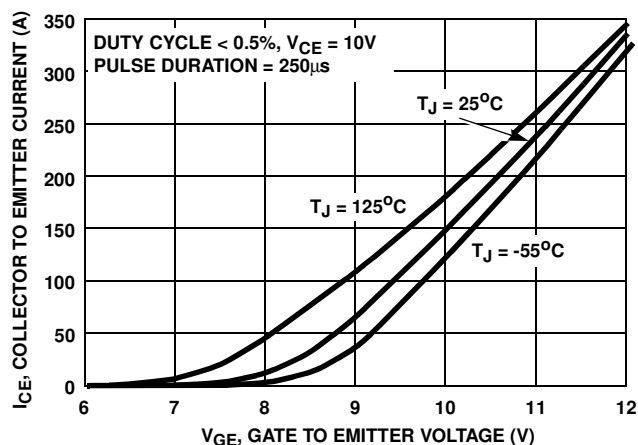

FIGURE 13. TRANSFER CHARACTERISTIC

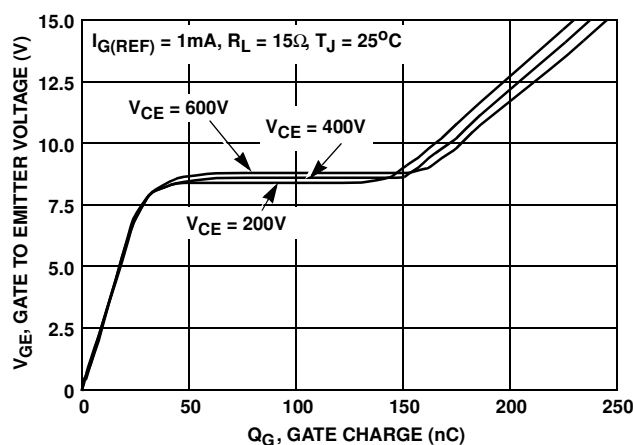

FIGURE 14. GATE CHARGE WAVEFORMS

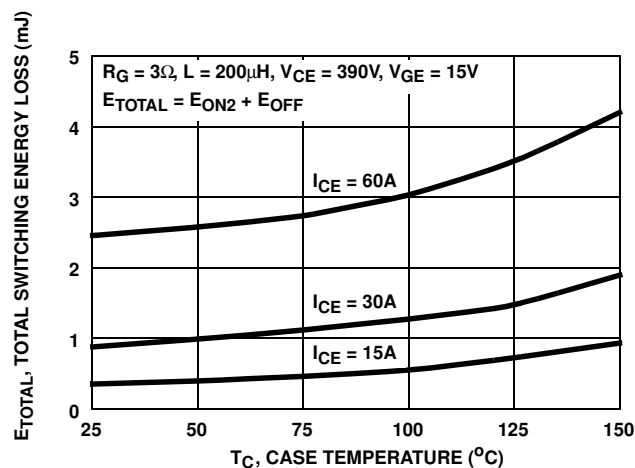

FIGURE 15. TOTAL SWITCHING LOSS vs CASE TEMPERATURE

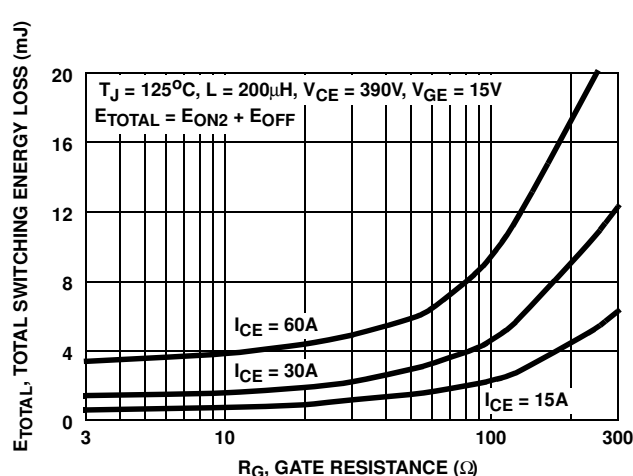

FIGURE 16. TOTAL SWITCHING LOSS vs GATE RESISTANCE

Typical Performance Curves Unless Otherwise Specified (Continued)

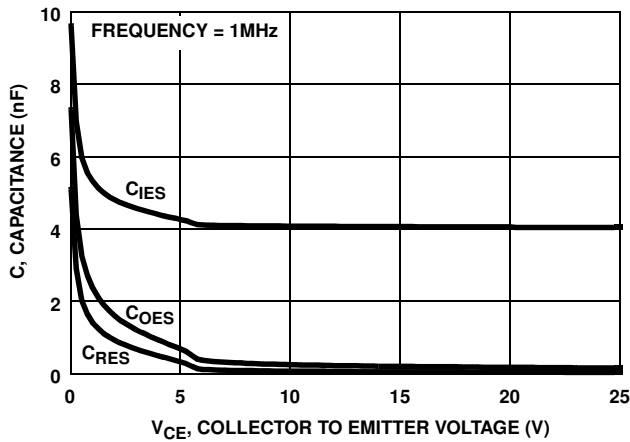

FIGURE 17. CAPACITANCE vs COLLECTOR TO EMITTER VOLTAGE

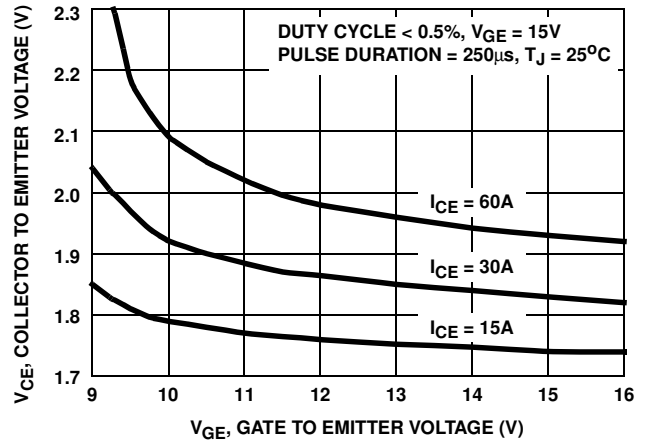

FIGURE 18. COLLECTOR TO EMITTER ON-STATE VOLTAGE vs GATE TO EMITTER VOLTAGE

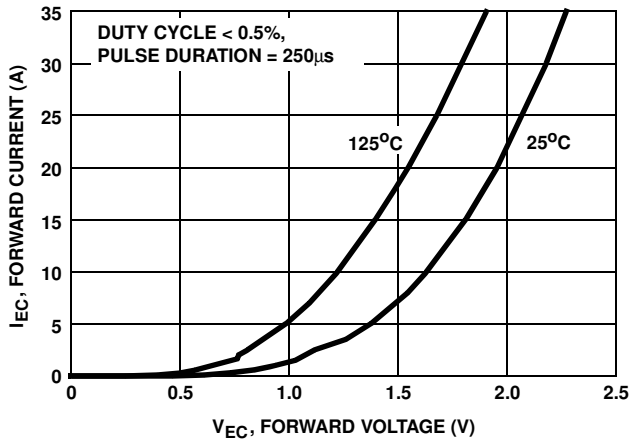

FIGURE 19. DIODE FORWARD CURRENT vs FORWARD VOLTAGE DROP

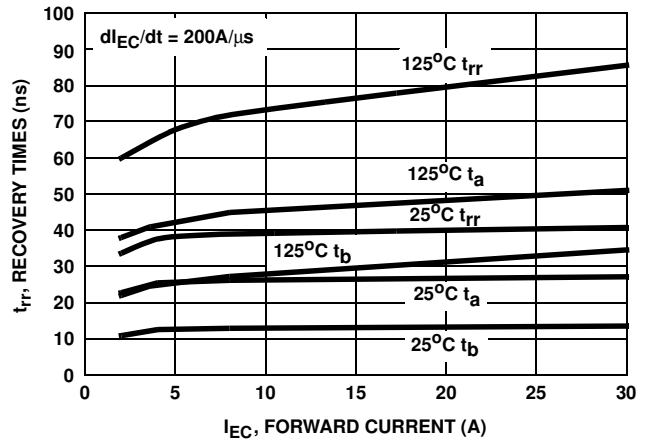

FIGURE 20. RECOVERY TIMES vs FORWARD CURRENT

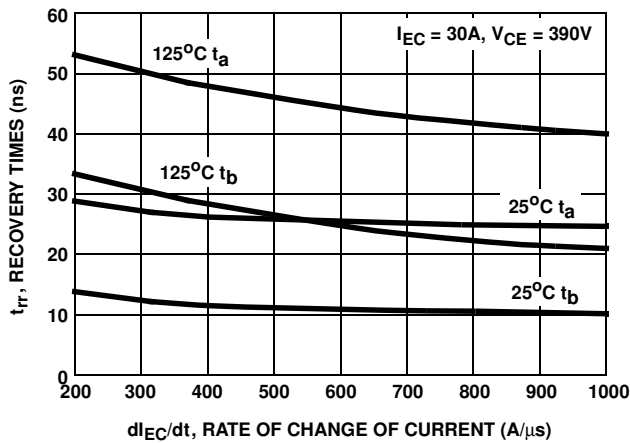

FIGURE 21. RECOVERY TIMES vs RATE OF CHANGE OF CURRENT

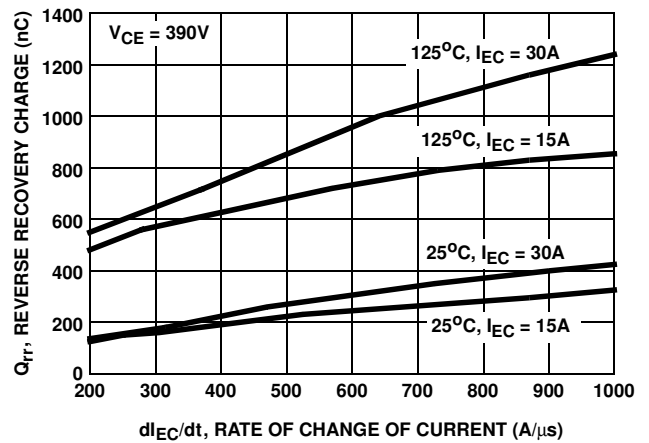

FIGURE 22. STORED CHARGE vs RATE OF CHANGE OF CURRENT

Typical Performance Curves Unless Otherwise Specified (Continued)

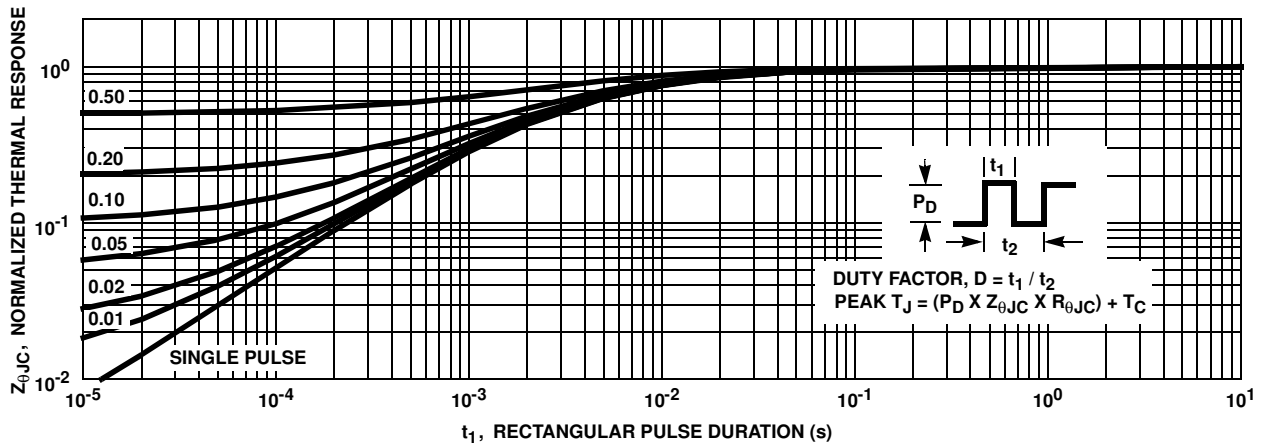

FIGURE 23. IGBT NORMALIZED TRANSIENT THERMAL RESPONSE, JUNCTION TO CASE

Test Circuit and Waveforms

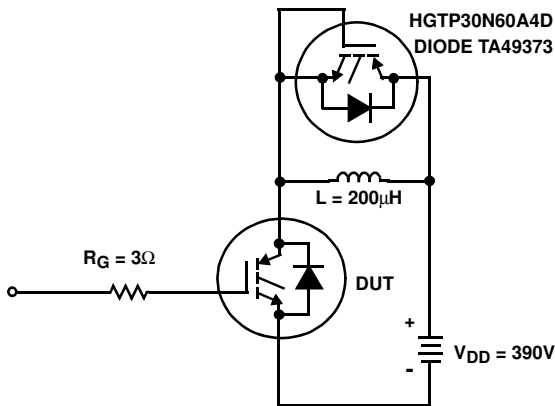

FIGURE 24. INDUCTIVE SWITCHING TEST CIRCUIT

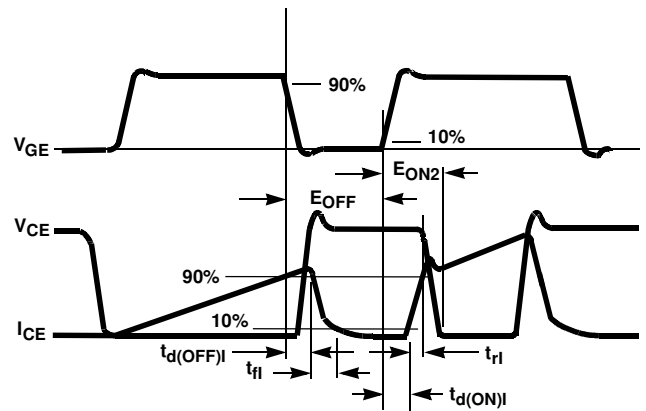

FIGURE 25. SWITCHING TEST WAVEFORMS

Handling Precautions for IGBTs

Insulated Gate Bipolar Transistors are susceptible to gate-insulation damage by the electrostatic discharge of energy through the devices. When handling these devices, care should be exercised to assure that the static charge built in the handler's body capacitance is not discharged through the device. With proper handling and application procedures, however, IGBTs are currently being extensively used in production by numerous equipment manufacturers in military, industrial and consumer applications, with virtually no damage problems due to electrostatic discharge. IGBTs can be handled safely if the following basic precautions are taken:

1. Prior to assembly into a circuit, all leads should be kept shorted together either by the use of metal shorting springs or by the insertion into conductive material such as "ECCOSORB™ LD26" or equivalent.
2. When devices are removed by hand from their carriers, the hand being used should be grounded by any suitable means - for example, with a metallic wristband.
3. Tips of soldering irons should be grounded.
4. Devices should never be inserted into or removed from circuits with power on.
5. **Gate Voltage Rating** - Never exceed the gate-voltage rating of V_{GEM} . Exceeding the rated V_{GE} can result in permanent damage to the oxide layer in the gate region.
6. **Gate Termination** - The gates of these devices are essentially capacitors. Circuits that leave the gate open-circuited or floating should be avoided. These conditions can result in turn-on of the device due to voltage buildup on the input capacitor due to leakage currents or pickup.
7. **Gate Protection** - These devices do not have an internal monolithic Zener diode from gate to emitter. If gate protection is required an external Zener is recommended.

Operating Frequency Information

Operating frequency information for a typical device (Figure 3) is presented as a guide for estimating device performance for a specific application. Other typical frequency vs collector current (I_{CE}) plots are possible using the information shown for a typical unit in Figures 5, 6, 7, 8, 9 and 11. The operating frequency plot (Figure 3) of a typical device shows f_{MAX1} or f_{MAX2} ; whichever is smaller at each point. The information is based on measurements of a typical device and is bounded by the maximum rated junction temperature.

f_{MAX1} is defined by $f_{MAX1} = 0.05 / (t_{d(OFF)I} + t_{d(ON)I})$. Deadtime (the denominator) has been arbitrarily held to 10% of the on-state time for a 50% duty factor. Other definitions are possible. $t_{d(OFF)I}$ and $t_{d(ON)I}$ are defined in Figure 25. Device turn-off delay can establish an additional frequency limiting condition for an application other than T_{JM} . $t_{d(OFF)I}$ is important when controlling output ripple under a lightly loaded condition.

f_{MAX2} is defined by $f_{MAX2} = (P_D - P_C) / (E_{OFF} + E_{ON2})$. The allowable dissipation (P_D) is defined by $P_D = (T_{JM} - T_C) / R_{\theta JC}$. The sum of device switching and conduction losses must not exceed P_D . A 50% duty factor was used (Figure 3) and the conduction losses (P_C) are approximated by $P_C = (V_{CE} \times I_{CE}) / 2$.

E_{ON2} and E_{OFF} are defined in the switching waveforms shown in Figure 25. E_{ON2} is the integral of the instantaneous power loss ($I_{CE} \times V_{CE}$) during turn-on and E_{OFF} is the integral of the instantaneous power loss ($I_{CE} \times V_{CE}$) during turn-off. All tail losses are included in the calculation for E_{OFF} ; i.e., the collector current equals zero ($I_{CE} = 0$).

TRADEMARKS

The following are registered and unregistered trademarks Fairchild Semiconductor owns or is authorized to use and is not intended to be an exhaustive list of all such trademarks.

ACEx™	FAST®	ISOPLANAR™	Power247™	SuperFET™
ActiveArray™	FASTr™	LittleFET™	PowerSaver™	SuperSOT™-3
Bottomless™	FPS™	MICROCOUPLER™	PowerTrench®	SuperSOT™-6
CoolFET™	FRFET™	MicroFET™	QFET®	SuperSOT™-8
CROSSVOLT™	GlobalOptoisolator™	MicroPak™	QS™	SyncFET™
DOMET™	GTO™	MICROWIRE™	QT Optoelectronics™	TinyLogic®
EcoSPARK™	HiSeC™	MSX™	Quiet Series™	TINYOPTO™
E ² CMOS™	ꝑC™	MSXPro™	RapidConfigure™	TruTranslation™
EnSigna™	i-Lo™	OCX™	RapidConnect™	UHC™
FACT™	ImpliedDisconnect™	OCXPro™	∞SerDes™	UltraFET®
FACT Quiet Series™		OPTOLOGIC®	SILENT SWITCHER®	VCX™
Across the board. Around the world.™		OPTOPLANAR™	SMART START™	
The Power Franchise®		PACMAN™	SPM™	
Programmable Active Droop™		POP™	Stealth™	

DISCLAIMER

FAIRCHILD SEMICONDUCTOR RESERVES THE RIGHT TO MAKE CHANGES WITHOUT FURTHER NOTICE TO ANY PRODUCTS HEREIN TO IMPROVE RELIABILITY, FUNCTION OR DESIGN. FAIRCHILD DOES NOT ASSUME ANY LIABILITY ARISING OUT OF THE APPLICATION OR USE OF ANY PRODUCT OR CIRCUIT DESCRIBED HEREIN; NEITHER DOES IT CONVEY ANY LICENSE UNDER ITS PATENT RIGHTS, NOR THE RIGHTS OF OTHERS.

LIFE SUPPORT POLICY

FAIRCHILD'S PRODUCTS ARE NOT AUTHORIZED FOR USE AS CRITICAL COMPONENTS IN LIFE SUPPORT DEVICES OR SYSTEMS WITHOUT THE EXPRESS WRITTEN APPROVAL OF FAIRCHILD SEMICONDUCTOR CORPORATION. As used herein:

1. Life support devices or systems are devices or systems which, (a) are intended for surgical implant into the body, or (b) support or sustain life, or (c) whose failure to perform when properly used in accordance with instructions for use provided in the labeling, can be reasonably expected to result in significant injury to the user.
2. A critical component is any component of a life support device or system whose failure to perform can be reasonably expected to cause the failure of the life support device or system, or to affect its safety or effectiveness.

PRODUCT STATUS DEFINITIONS

Definition of Terms

Datasheet Identification	Product Status	Definition
Advance Information	Formative or In Design	This datasheet contains the design specifications for product development. Specifications may change in any manner without notice.
Preliminary	First Production	This datasheet contains preliminary data, and supplementary data will be published at a later date. Fairchild Semiconductor reserves the right to make changes at any time without notice in order to improve design.
No Identification Needed	Full Production	This datasheet contains final specifications. Fairchild Semiconductor reserves the right to make changes at any time without notice in order to improve design.
Obsolete	Not In Production	This datasheet contains specifications on a product that has been discontinued by Fairchild semiconductor. The datasheet is printed for reference information only.