

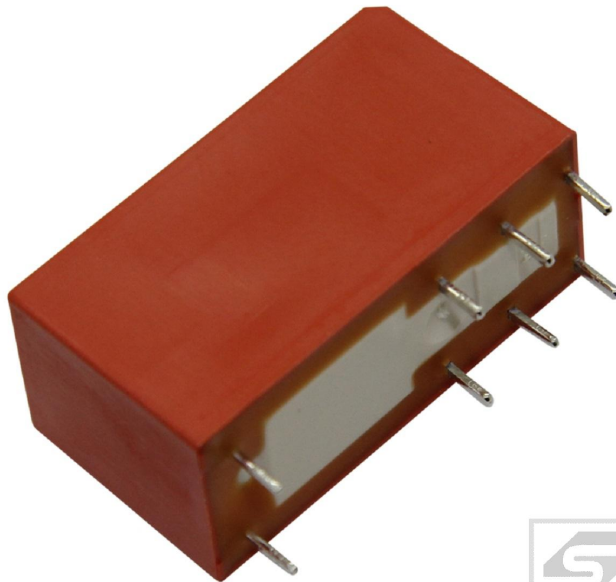

Przełącznik RT424024;24VDC;8A/250VAC TE Connectivity;RoHS



Dane techniczne:

Nazwa: RT424024

Konfiguracja styków: 2 styki przełączne(DPDT)

Napięcie cewki: 24VDC

Obciążalność styków: 8A/250VAC

Producent: TE Connectivity

Certyfikat: RoHS

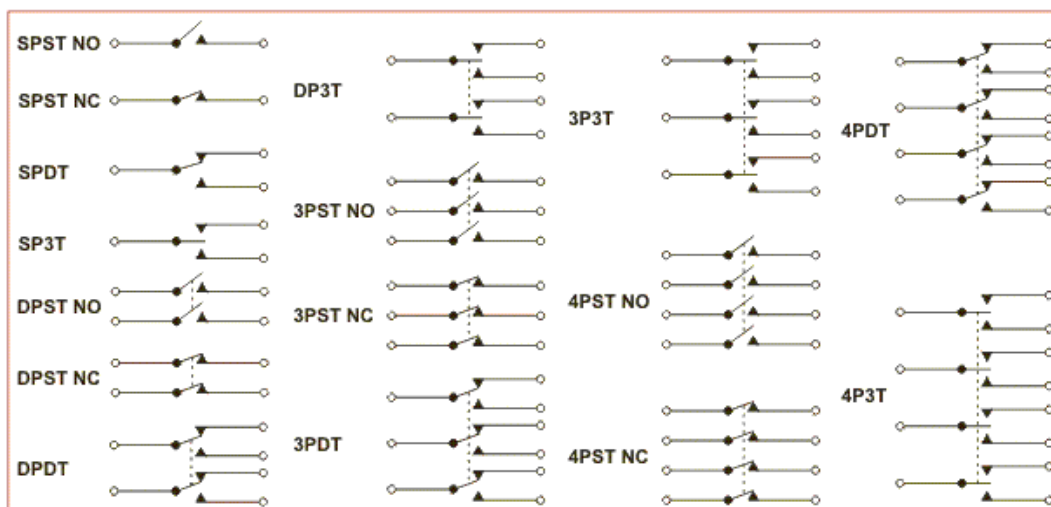

Power PCB Relay RT2 DC and AC (for global markets)

- 2 pole 8A, 2 form C (CO) or 2 form A (NO) contacts
- DC or AC coil
- 5kV/10mm coil-contact, reinforced insulation
- Ambient temperature up to 85°C
- WG version: product in accordance to IEC60335-1
- Reflow version: for THR (Through-Hole Reflow) soldering process



Typical applications
Boiler control, timers, garage door control, POS automation, interface modules.

Approvals

VDE Cert. No. 40007571, UL E214025, cCSAus 1142018
Technical data of approved types on request.

Contact Data

Contact arrangement	2 form C (CO) or 2 form A (NO)
Rated voltage	250VAC
Max. switching voltage	400VAC
Rated current	8A, UL: 10A
Limiting continuous current	8A, UL: 10A
Limiting making current, max. 4s, duty factor 10%	15A
Breaking capacity max.	2000VA
Contact material	AgNi 90/10, AgNi 90/10 gold plated, AgSnO ₂
Frequency of operation, with/without load	
DC coil	360/72000h ⁻¹
AC coil	360/36000h ⁻¹
Operate/release time max., DC coil	8/6ms
Bounce time max., DC coil, form A/form B	4/10ms
Electrical endurance	see electrical endurance graph ¹⁾

Contact ratings

Type	Contact	Load	Cycles
IEC 61810			
RT424 DC coil	C (CO)	8A, 250VAC, cosφ=1, 85°C	10x10 ³
RT444 AC coil	A (NO)	8A, 250VAC, cosφ=1, 70°C	50x10 ³
RT424 AC coil	C (CO)	8A, 250VAC, cosφ=1, 70°C	30x10 ³

UL 508

RT424 DC coil	A/B (NO/NC)	10A, 250VAC, gen. purpose, 85°C	20x10 ³
RT424 DC coil	A/B (NO/NC)	1/2hp, 240VAC, 85°C	1x10 ³
RT424 DC coil	A/B (NO/NC)	Pilot duty, B300, R300, 85°C	6x10 ³

EN60947-5-1

RTE24 DC coil	A/B (NO/NC)	AC15, 250VAC, 3A	6.050
RTE24 DC coil	A/B (NO/NC)	DC13, 24VDC, 2A	6.050
RTE24 DC coil	A/B (NO/NC)	DC13, 250VDC, 0.2A	6.050

EN60730-1

RT424 DC coil	A/B (NO/NC)	6(2)A, 250VAC, 85°C	100x10 ³
---------------	-------------	---------------------	---------------------

1) For reflow solderable versions: actual contact performance may be influenced by the reflow soldering process.

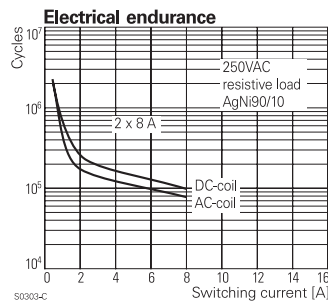
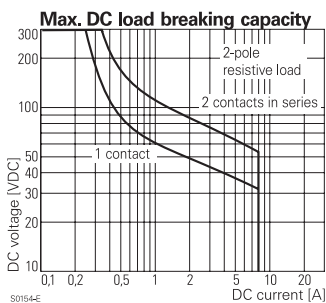

Contact Data (continued)

Mechanical endurance	
DC coil	>30x10 ⁶ operations
DC coil, reflow version	>10x10 ⁶ operations
AC coil	>5x10 ⁶ operations
AC coil, reflow version	>2x10 ⁶ operations

Coil Data

Coil voltage range, DC coil/AC coil	5 to 110VDC / 24 to 230VAC
Operative range, IEC 61810	2
Coil insulation system according UL	class F

Coil versions, DC coil

Coil code	Rated voltage VDC	Operate voltage VDC	Release voltage VDC	Coil resistance Ω±10% ²⁾	Rated coil power mW
005	5	3.5	0.5	62	403
006	6	4.2	0.6	90	400
009	9	6.3	0.9	200	400
012	12	8.4	1.2	360	400
024	24	16.8	2.4	1440	400
048	48	33.6	4.8	5520	417
060	60	42.0	6.0	8570 ²⁾	420
110	110	77.0	11.0	28800 ²⁾	420

2) Coil resistance ±12%. All figures are given for coil without pre-energization, at ambient temperature +23°C. Other coil voltages on request.

Coil versions, AC coil 50Hz

Coil code	Rated voltage VAC	Operate voltage VAC	Release voltage VAC	Coil resistance Ω±15% ³⁾	Rated coil power VA
524	24	18.0	3.6	350 ³⁾	0.76
615	115	86.3	17.3	8100	0.76
620	120	90.0	18.0	8800	0.75
700	200	150.0	30.0	24350	0.76
730	230	172.5	34.5	32500	0.74

3) Coil resistance ±10%. All figures are given for coil without pre-energization, at ambient temperature +23°C, 50Hz. Other coil voltages on request.

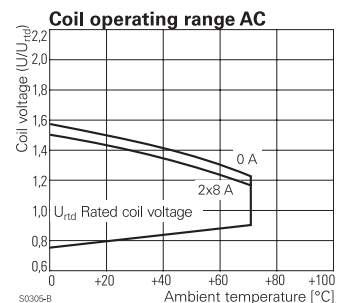
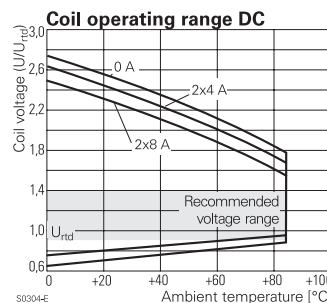

Power PCB Relay RT2 DC and AC (for global markets) (Continued)

Insulation Data

Initial dielectric strength	
between open contacts	1000V _{rms}
between contact and coil	5000V _{rms}
between adjacent contacts	2500V _{rms}
Clearance/creepage	
between contact and coil	≥10/10mm
between adjacent contacts	≥3/4mm
Material group of insulation parts	IIIa
Tracking index of relay base	PTI 250V
reflow version	PTI 175V

Other Data

Material compliance: EU RoHS/ELV, China RoHS, REACH, Halogen content refer to the Product Compliance Support Center at www.te.com/customer-support/rohssupportcenter

Resistance to heat and fire	
WG version or reflow version	according EN60335, par30
Ambient temperature	
DC coil	-40 to 85°C
AC coil	-40 to 70°C
AgSnO ₂ contacts	-40 to 70°C
Category of environmental protection, IEC 61810	
standard version	RTII - flux proof, RTIII - wash tight
reflow version	RTII - flux proof
Vibration resistance (functional), form A/form B contact, 30 to 300Hz	20g/5g
Shock resistance (destructive)	100g

Other Data (continued)

Terminal type	PCB-THT, plug-in
reflow version	PCB-THR
Mounting distance, AC coil	≥2.5mm
Weight	13g
Resistance to soldering heat THT, IEC 60068-2-20	
RTII	270°C/10s
RTIII	260°C/5s
Resistance to soldering heat THR	
reflow soldering (for reflow version)	forced gas convection ⁴⁾ or vapour phase ⁵⁾
temperature profile	according EN61730
Packaging/unit	tube/20pcs., box/500pcs.

4) infrared heating not allowed.
5) recommended fluid LS/230.

Accessories

For details see datasheet [Accessories Industrial Power Relay RT](#)
NOTE: indicated contact ratings and electrical endurance data for direct wiring of relays (according IEC 61810-1); for relays mounted on sockets deratings may apply.

Dimensions

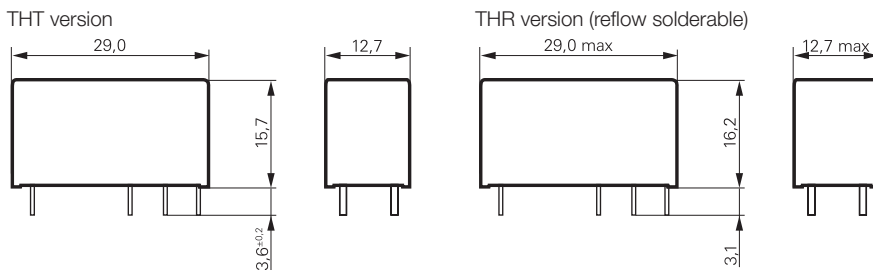

PCB layout / terminal assignment

Bottom view on solder pins

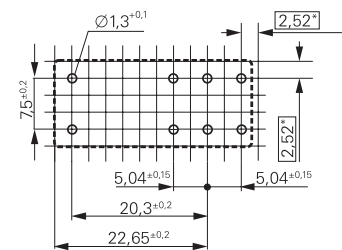

*) With the recommended PCB hole sizes a grid pattern from 2.5mm to 2.54mm can be used.

Process conditions for Reflow soldering

according to EN61760-1

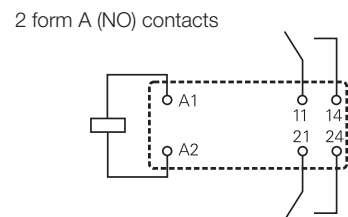
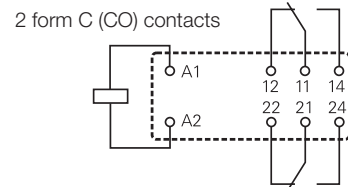
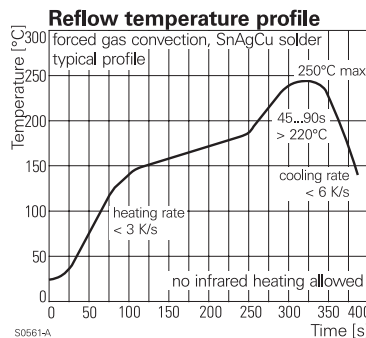
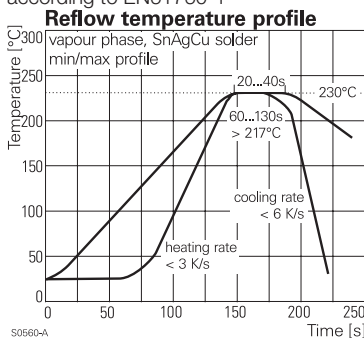

Power PCB Relay RT2 DC and AC (for global markets) (Continued)

Product code structure		Typical product code	RT	4	2	4	024
Type		RT Power PCB Relay RT2					
Version		4 8A, pinning 5mm, flux proof E 8A, pinning 5mm, wash tight (not for Reflow version)					
Contact arrangement		2 2 form C (CO) contacts 4 2 form A (NO) contacts					
Contact material		3 AgSnO 4 AgNi 90/10 5 AgNi 90/10 gold plated					
Coil		Coil code: please refer to coil versions table					
Version		Blank Standard version WG Product in accordance with IEC 60335-1 (domestic appliances) R Reflow solderable					

Product code	Version	Contacts	Contact material	Coil	Version	Part number
RT423730	8A,	2 form C (CO)	AgSnO	230VAC	Standard	4-1393243-3
RT424005	pinning 5mm,	contacts	AgNi 90/10	5VDC		5-1393243-9
RT424006	flux proof			6VDC		6-1393243-1
RT424012				12VDC		6-1393243-3
RT424012WG					IEC60335-1 compliant	7-1415538-8
RT424024				24VDC	Standard	6-1393243-8
RT424024WG					IEC60335-1 compliant	7-1415538-7
RT424048				48VDC	Standard	7-1393243-0
RT424060				60VDC		7-1393243-3
RT424110				110VDC		7-1393243-5
RT424524				24VAC		7-1393243-6
RT424615				115VAC		7-1393243-8
RT424730				230VAC		7-1393243-9
RT425003			AgNi 90/10	3VDC		7-1415525-1
RT425005			gold plated	5VDC		8-1393243-0
RT425012				12VDC		8-1393243-2
RT425024				24VDC		8-1393243-5
RT444012		2 form A (NO)	AgNi 90/10	12VDC		9-1393243-7
RT444024		contacts		24VDC		9-1393243-9
RTE24005	8A,	2 form C (CO)		5VDC		1393243-1
RTE24006	pinning 5mm,	contacts		6VDC		1393243-2
RTE24012	wash tight			12VDC		1393243-4
RTE24024				24VDC		1-1393243-0
RTE24048				48VDC		1-1393243-1
RTE24110				110VDC		1-1393243-4
RTE24524				24VAC		1-1393243-5
RTE24615				115VAC		1-1393243-7
RTE24730				230VAC		1-1393243-8
RTE25005			AgNi 90/10	5VDC		1-1393243-9
RTE25012			gold plated	12VDC		2-1393243-0
RTE25024				24VDC		2-1393243-1
RTE25524						2-1393243-4
RTE43009		2 form A (NO)	AgSnO	9VDC		4-1415535-1
RTE44009		contacts	AgNi 90/10			3-1393243-1
RTE44730				230VAC		3-1393243-5

This list represents the most common types and does not show all variants covered by this datasheet. Other types on request.

