



Przełącznik LAS1-AY-11Z/Y/12V;ON-ON żółty;podśw.LED 12V;5A/250V;bistab.



Dane techniczne:

Rodzaj przełącznika: przyciskowy

Sposób przełączania: ON-(ON)

Ilość torów: 1 tor

Kolor elementu wykonawczego: żółty

Podświetlenie: podświetlenie LED 12V

Kolor podświetlenia: żółty

Typ przełącznika: bistabilny

Montaż mechaniczny: na panel

Wyprowadzenia: do lutowania

Ilość pozycji: 2 pozycje

Prąd styków AC: 5A

Napięcie przełączania AC: 250V AC

Otwór montażowy / raster: 16mm

Głębokość montażowa: 30mm

Kolor korpusu: czarny

Materiał korpusu: plastik

Klasa szczelności: IP40

Certyfikaty: RoHS

www.podzespoly-elektroniczne.pl

LAS1 Series A Type Pushbutton Switches

Characteristic

Specs

Having three head shape: round ($\Phi 18\text{mm}$), square ($18 \times 18\text{mm}$) and rectangular ($18 \times 24\text{mm}$), containing pilot lamps, pushbuttons, illuminated push buttons, selector switches, key-lock switches, buzzer and emergency switches. The normal diameter of the installation hole is $\Phi 16\text{mm}$, and some type can be installed in $\Phi 22\text{mm}$ hole easily with the diameter changing circle.

Functions

The product has stable property, small contact resistance, strong insulation resistance, anti-vibration and so on. It meets to standards of IEC60947-5-1, GB14048.5 etc.

Structure

The switch have the advantage of fast-break and self-cleaning, and each of them contains 1NO and 1NC terminal. Every pushbutton also can possess from one to two switch units.

Protective Degree

Its protective degree is IP40, IP65, some of type can reach IP67 with the seal cover.

Lamp Ratings

Lamp Type	AC LED Lamp (Standard)			Neon Lamp		
	AC/DC6V	AC/DC12V	AC/DC24V	AC110V	AC220V	
Rated Voltage	AC/DC110V		AC/DC220V			
Cover Color:	R	G	Y	O	B	W
Life	About 40,000 hours			About 20,000 hours		

Note: the lamp contains a current-limiting resistor inside and doesn't need external connection.

DC LED lamp, dual-color LED lamp and other voltages can be customized.

Installation Dimensions

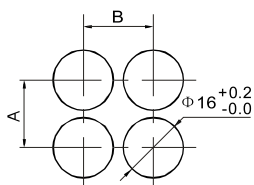

Category	A	B
Round	$\geq 18\text{mm}$	$\geq 18\text{mm}$
Square	$\geq 18\text{mm}$	$\geq 18\text{mm}$
Rectangular	$\geq 18\text{mm}$	$\geq 24\text{mm}$
Mushroom	$\geq 24\text{mm}$	$\geq 24\text{mm}$
Big square	$\geq 24\text{mm}$	$\geq 24\text{mm}$
Big rectangular	$\geq 18\text{mm}$	$\geq 24\text{mm}$

Switch Ratings

Thermal Current I _{th}	5A		
Rated Voltage	24V	125V(110V)	250V(220V)
Direct Current	1A	0.2A	0.1A
Alternating Current	P.F=1	5A	3A
	P.F=0.7	3A	2A

Specifications

Operating Temperature	-25°C ~ +55°C (no freezing)	
Operating Humidity	45 ~ 85%RH (no condensation)	
Contact Material	- silver - silver alloy - gold-clad silver, cladding thickness is 3 μm	
Contact Resistance	$\leq 50\text{M}\Omega$	
Insulation Resistance	$\geq 100\text{M}\Omega$	
Dielectric strength	Between contact and lamp terminals: 2000V, AC 50Hz, 1 min	
	Between terminal of the same pole: 1000V, AC 50Hz, 1 min	
	Between terminal of different pole: 2000V, AC 50Hz, 1 min	
Vibration Resistance	50Hz, Amplitude 1.2mm p-p	
Shock Resistance	$\geq 10\text{g}$	
Life	Mechanical	
	Momentary Type	1,000,000 times
	Alternate and Selector Type	500,000 times
	Key-lock and Emergency Type	200,000 times
Electrical	$\geq 50,000$ times	
Terminal	Diameter of welded wire: $2 \times 0.8\text{mm}$ Area of copper wire: 0.75mm^2 max Connecting link: $2.8 \times 0.5\text{mm}$	
Solder Heat Resistance	230°C (no more than 3 second)	
Operating Travel	(Pushbuttons) about 3mm	

Bottom View

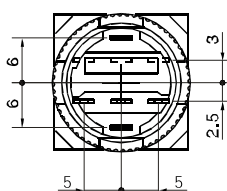

Terminal Arrangement

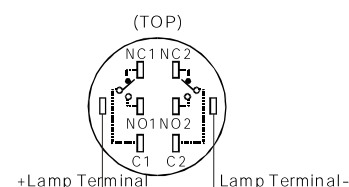



Implication of Type

LAS1-A	★	-	□	■	/	◇	◆	/	△	/	▲	/	◎
Code of series	The front shape: Y round F square J rectangular M mushroom DF big square DJ big rectangular	Contact Structure: 11 1NO1NC 22 2NO2NC	Code name of derivative products: D pilot lamp Z alternate type X selector type Y key-lock type TS emergency B buzzer type No letter means momentary	◇: expresses selector and key-lock series: 2 two position 3 three position ◆: expresses key-lock retention position	color: R red G green Y yellow O orange B blue W white N black	Lamp Voltage (Please check the lamp rating)	Protective Degree: P IP65 FP IP67 No letter means IP40						

LAS1-A Pilot Lamp

Product Cutline

Model Number	LAS1-AY-D/Δ/▲/◎	LAS1-AF-D/Δ/▲/◎	LAS1-AJ-D/Δ/▲/◎
Shape			
Remarks	R G Y O B W		



LAS1-A Pushbuttons, Illuminated Pushbuttons

Product Cutline

Note: SPDT single - pole double - throw, DPDT double - pole double Throw.

Shape	Contact	Operating Type	Type Number	Remarks
Round (can be illuminated) 	SPDT	Momentary	LAS1-AY-11/Δ/▲/◎	<div style="display: flex; justify-content: space-around; align-items: center;"> R G Y O B W N </div> <ul style="list-style-type: none"> ◎ The black cover can't be used with the illuminated push buttons ◎ Protective Degree: IP40, IP65, IP67; IP67 should be installed with seal covers.
		Alternate	LAS1-AY-11Z/Δ/▲/◎	
	DPDT	Momentary	LAS1-AY-22/Δ/▲/◎	
		Alternate	LAS1-AY-22Z/Δ/▲/◎	
Square (can be illuminated) 	SPDT	Momentary	LAS1-AF-11/Δ/▲/◎	
		Alternate	LAS1-AF-11Z/Δ/▲/◎	
	DPDT	Momentary	LAS1-AF-22/Δ/▲/◎	
		Alternate	LAS1-AF-22Z/Δ/▲/◎	
Rectangular (can be illuminated) 	SPDT	Momentary	LAS1-AJ-11/Δ/▲/◎	
		Alternate	LAS1-AJ-11Z/Δ/▲/◎	
	DPDT	Momentary	LAS1-AJ-22/Δ/▲/◎	
		Alternate	LAS1-AJ-22Z/Δ/▲/◎	
Mushroom (can be illuminated) 	SPDT	Momentary	LAS1-AM-11/Δ/▲/◎	<div style="display: flex; justify-content: space-around; align-items: center;"> R G Y </div> <ul style="list-style-type: none"> ◎ Protective Degree: IP40, IP65.
		Alternate	LAS1-AM-11Z/Δ/▲/◎	
	DPDT	Momentary	LAS1-AM-22/Δ/▲/◎	
		Alternate	LAS1-AM-22Z/Δ/▲/◎	

Note: SPDT signal-pole double-throw, DPDT double-pole double-throw.

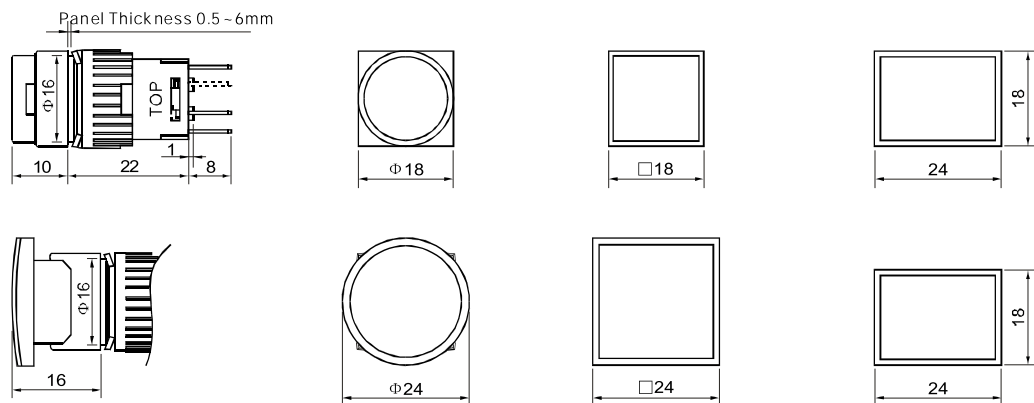

Shape	Contact	Operating Type	Type Number	Remarks
Big Square(can be illuminated) 	SPDT	Momentary	LAS1-ADF-11/△/▲/◎	 ◎ Protective Degree: IP40, IP65.
		Alternate	LAS1-ADF-11Z/△/▲/◎	
	DPDT	Momentary	LAS1-ADF-22/△/▲/◎	
		Alternate	LAS1-ADF-22Z/△/▲/◎	
Big Rectangular(can be illuminated) 	SPDT	Momentary	LAS1-ADJ-11/△/▲/◎	
		Alternate	LAS1-ADJ-11Z/△/▲/◎	
	DPDT	Momentary	LAS1-ADJ-22/△/▲/◎	
		Alternate	LAS1-ADJ-22Z/△/▲/◎	

Shape and Dimensions



LAS1-A Selector Switches



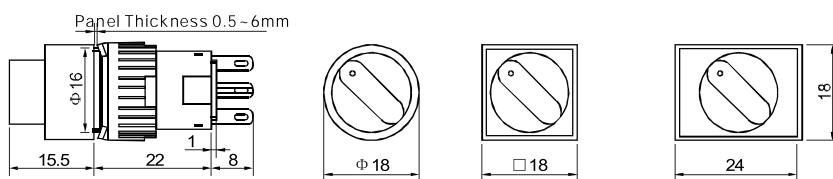

Product Cutline

Shape	Position	Contact	Type Number	Remarks
Round(can be illuminated) 	$\begin{matrix} L & & R \\ & \diagdown & / \\ & \text{C} & \end{matrix}$ 90° 2 Position	SPDT	LAS1-AY-11X/2/Δ/▲/◎	<div style="display: flex; align-items: center; gap: 5px;"> R G Y N </div> <ul style="list-style-type: none"> ◎ The black cover can't be used with the illuminated push buttons ◎ Protective Degree: IP40, IP65.
		DPDT	LAS1-AY-22X/2/Δ/▲/◎	
	$\begin{matrix} L & C & R \\ & \diagdown & / \\ & \text{C} & \end{matrix}$ 45° 3 Position	DPDT	LAS1-AY-22X/3/Δ/▲/◎	
Square(can be illuminated) 	$\begin{matrix} L & & R \\ & \diagdown & / \\ & \text{C} & \end{matrix}$ 90° 2 Position	SPDT	LAS1-AF-11X/2/Δ/▲/◎	
		DPDT	LAS1-AF-22X/2/Δ/▲/◎	
	$\begin{matrix} L & C & R \\ & \diagdown & / \\ & \text{C} & \end{matrix}$ 45° 3 Position	DPDT	LAS1-AF-22X/3/Δ/▲/◎	
Rectangular(can be illuminated) 	$\begin{matrix} L & & R \\ & \diagdown & / \\ & \text{C} & \end{matrix}$ 90° 2 Position	SPDT	LAS1-AJ-11X/2/Δ/▲/◎	
		DPDT	LAS1-AJ-22X/2/Δ/▲/◎	
	$\begin{matrix} L & C & R \\ & \diagdown & / \\ & \text{C} & \end{matrix}$ 45° 3 Position	DPDT	LAS1-AJ-22X/3/Δ/▲/◎	

Shape and Dimensions



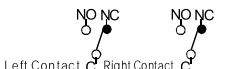
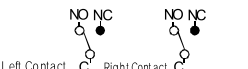

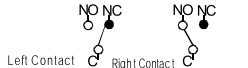
Contact Operation

Position	Contact	Operating Position & Contact Operation		
		Left	Center	Right
90° 2 Position	1C		/	
	2C			
45° 3 Position	2C			

LAS1-A Key-lock Switches

Product Cutline

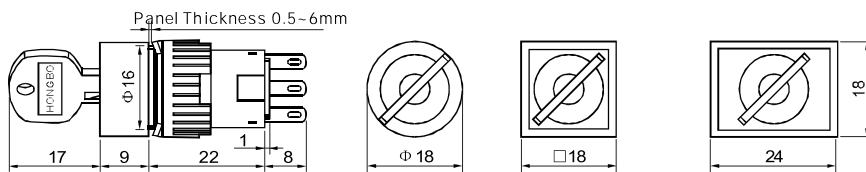

Shape	Position	Key Retained at Position ●	Contact	Type	Remarks
Round 	$\begin{matrix} L & & R \\ & \diagdown & / \\ & \text{V} & \end{matrix}$ 90° 2 Position		SPDT	LAS1-AY-11Y/2A/⊙	<ul style="list-style-type: none"> ⊙ Two keys are supplied. ⊙ All the keys are same. ⊙ Protective Degree: IP40, IP65
			DPDT	LAS1-AY-22Y/2A/⊙	
			SPDT	LAS1-AY-11Y/2B/⊙	
			DPDT	LAS1-AY-22Y/2B/⊙	
			SPDT	LAS1-AY-11Y/2C/⊙	
			DPDT	LAS1-AY-22Y/2C/⊙	
	$\begin{matrix} L & & C & & R \\ & \diagdown & & \diagup & \\ & \text{V} & & \text{V} & \end{matrix}$ 45° 3 Position		DPDT	LAS1-AY-22Y/3A/⊙	
			DPDT	LAS1-AY-22Y/3B/⊙	
			DPDT	LAS1-AY-22Y/3C/⊙	
			DPDT	LAS1-AY-22Y/3D/⊙	
			DPDT	LAS1-AY-22Y/3E/⊙	
			DPDT	LAS1-AY-22Y/3G/⊙	
			DPDT	LAS1-AY-22Y/3H/⊙	
			DPDT	LAS1-AY-22Y/3H/⊙	
Square 	$\begin{matrix} L & & R \\ & \diagdown & / \\ & \text{V} & \end{matrix}$ 90° 2 Position		SPDT	LAS1-AF-11Y/2A/⊙	
			DPDT	LAS1-AF-22Y/2A/⊙	
			SPDT	LAS1-AF-11Y/2B/⊙	
			DPDT	LAS1-AF-22Y/2B/⊙	
			SPDT	LAS1-AF-11Y/2C/⊙	
			DPDT	LAS1-AF-22Y/2C/⊙	
	$\begin{matrix} L & & C & & R \\ & \diagdown & & \diagup & \\ & \text{V} & & \text{V} & \end{matrix}$ 45° 3 Position		DPDT	LAS1-AF-22Y/3A/⊙	
			DPDT	LAS1-AF-22Y/3B/⊙	
			DPDT	LAS1-AF-22Y/3C/⊙	
			DPDT	LAS1-AF-22Y/3D/⊙	
			DPDT	LAS1-AF-22Y/3E/⊙	
			DPDT	LAS1-AF-22Y/3G/⊙	
			DPDT	LAS1-AF-22Y/3H/⊙	
			DPDT	LAS1-AF-22Y/3H/⊙	
rectangular 	$\begin{matrix} L & & R \\ & \diagdown & / \\ & \text{V} & \end{matrix}$ 90° 2 Position		SPDT	LAS1-AJ-11Y/2A/⊙	
			DPDT	LAS1-AJ-22Y/2A/⊙	
			SPDT	LAS1-AJ-11Y/2B/⊙	
			DPDT	LAS1-AJ-22Y/2B/⊙	
			SPDT	LAS1-AJ-11Y/2C/⊙	
			DPDT	LAS1-AJ-22Y/2C/⊙	
	$\begin{matrix} L & & C & & R \\ & \diagdown & & \diagup & \\ & \text{V} & & \text{V} & \end{matrix}$ 45° 3 Position		DPDT	LAS1-AJ-22Y/3A/⊙	
			DPDT	LAS1-AJ-22Y/3B/⊙	
			DPDT	LAS1-AJ-22Y/3C/⊙	
			DPDT	LAS1-AJ-22Y/3D/⊙	
			DPDT	LAS1-AJ-22Y/3E/⊙	
			DPDT	LAS1-AJ-22Y/3G/⊙	
			DPDT	LAS1-AJ-22Y/3H/⊙	
			DPDT	LAS1-AJ-22Y/3H/⊙	

Shape and Dimensions



LAS1-A Emergency Pushbutton

Product Cutline

Shape	Contact	Type Number	Remrks
	SPDT	LAS1-AY-11TS/Δ/⊙	 ◎ Protective Degree: IP40, IP65
	DPDT	LAS1-AY-22TS/Δ/⊙	

Shape and Dimensions

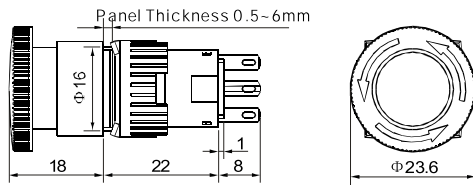

LAS1-A Buzzer Units

Specifications

Operating Temperature	-25°C ~ 55°C
Operating Humidity	45 - 85%RH
Dielectric Strength	1000V
Sound Duration	Continuous, Discontinuous
Rated Sound Pressure & Frequency	75dB(1m)(Rated Voltage) 2300 ± 300Hz
Operating Voltage	6VDC; 12VDC; 24VDC; 110VAC; 220VAC

Shape and Dimensions

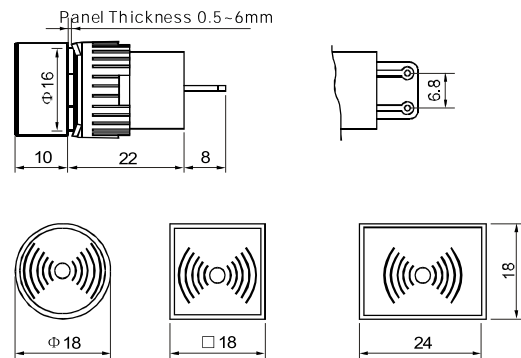

Product Cutline

Type Number	LAS1-AY-B/▲	LAS1-AF-B/▲	LAS1-AJ-B/▲
Shape			