

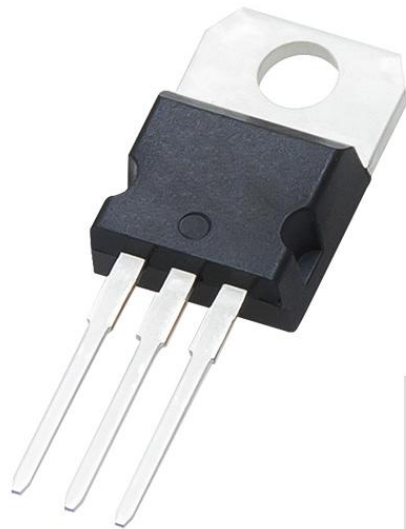

ROBERT STĘPIEŃ
HURTOWNIA CZĘŚCI ELEKTRONICZNYCH
podzespoly-elektroniczne.pl

IRF1407;IR;TO220; tranzystor; N- MOSFET;130A;75V;330W;0.0078R;Pbf



Dane techniczne:

Nazwa: IRF1407

Typ tranzystora: unipolarny

Kierunek przewodnictwa: N-MOSFET

Prąd kolektora: 130A

Napięcie kolektor-emiter: 75V

Moc: 330W

Montaż: przewlekany(THT)

Obudowa: TO220

Producent: IR

www.podzespoly-elektroniczne.pl

Robert Stępień Hurtownia Części Elektronicznych; Adres: ul. Wolumen 2, pawilon 71; 01-912 Warszawa; tel.: 601 296 402 /
sklep@podzespoly-elektroniczne.pl

Typical Applications

- Integrated Starter Alternator
- 42 Volts Automotive Electrical Systems

Benefits

- Advanced Process Technology
- Ultra Low On-Resistance
- Dynamic dv/dt Rating
- 175°C Operating Temperature
- Fast Switching
- Repetitive Avalanche Allowed up to Tjmax

Description

Specifically designed for Automotive applications, this Stripe Planar design of HEXFET® Power MOSFETs utilizes the latest processing techniques to achieve extremely low on-resistance per silicon area. Additional features of this HEXFET power MOSFET are a 175°C junction operating temperature, fast switching speed and improved repetitive avalanche rating. These benefits combine to make this design an extremely efficient and reliable device for use in Automotive applications and a wide variety of other applications.

HEXFET® Power MOSFET

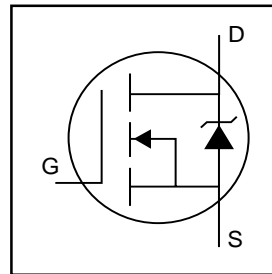

$V_{DSS} = 75V$
$R_{DS(on)} = 0.0078\Omega$
$I_D = 130A\text{⑥}$

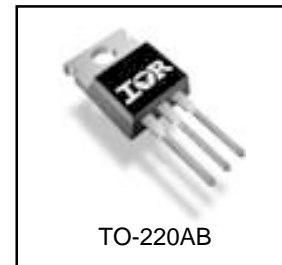

Absolute Maximum Ratings

	Parameter	Max.	Units
$I_D @ T_C = 25^\circ C$	Continuous Drain Current, $V_{GS} @ 10V$	130⑥	A
$I_D @ T_C = 100^\circ C$	Continuous Drain Current, $V_{GS} @ 10V$	92⑥	
I_{DM}	Pulsed Drain Current ①	520	
$P_D @ T_C = 25^\circ C$	Power Dissipation	330	W
	Linear Derating Factor	2.2	W/°C
V_{GS}	Gate-to-Source Voltage	± 20	V
E_{AS}	Single Pulse Avalanche Energy②	390	mJ
I_{AR}	Avalanche Current①	See Fig.12a, 12b, 15, 16	A
E_{AR}	Repetitive Avalanche Energy②		mJ
dv/dt	Peak Diode Recovery dv/dt ③	4.6	V/ns
T_J	Operating Junction and	-55 to + 175	°C
T_{STG}	Storage Temperature Range		
	Soldering Temperature, for 10 seconds		
	Mounting Torque, 6-32 or M3 screw	10 lbf•in (1.1N•m)	

Thermal Resistance

	Parameter	Typ.	Max.	Units
$R_{\theta JC}$	Junction-to-Case	—	0.45	°C/W
$R_{\theta CS}$	Case-to-Sink, Flat, Greased Surface	0.50	—	
$R_{\theta JA}$	Junction-to-Ambient	—	62	

Electrical Characteristics @ T_J = 25°C (unless otherwise specified)

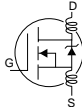
	Parameter	Min.	Typ.	Max.	Units	Conditions
V _{(BR)DSS}	Drain-to-Source Breakdown Voltage	75	—	—	V	V _{GS} = 0V, I _D = 250μA
ΔV _{(BR)DSS} /ΔT _J	Breakdown Voltage Temp. Coefficient	—	0.09	—	V/°C	Reference to 25°C, I _D = 1mA
R _{DS(on)}	Static Drain-to-Source On-Resistance	—	—	0.0078	Ω	V _{GS} = 10V, I _D = 78A ④
V _{GS(th)}	Gate Threshold Voltage	2.0	—	4.0	V	V _{DS} = 10V, I _D = 250μA
g _{fs}	Forward Transconductance	74	—	—	S	V _{DS} = 25V, I _D = 78A
I _{DSS}	Drain-to-Source Leakage Current	—	—	20	μA	V _{DS} = 75V, V _{GS} = 0V
		—	—	250		V _{DS} = 60V, V _{GS} = 0V, T _J = 150°C
I _{GSS}	Gate-to-Source Forward Leakage	—	—	200	nA	V _{GS} = 20V
	Gate-to-Source Reverse Leakage	—	—	-200		V _{GS} = -20V
Q _g	Total Gate Charge	—	160	250	nC	I _D = 78A
Q _{gs}	Gate-to-Source Charge	—	35	52		V _{DS} = 60V
Q _{gd}	Gate-to-Drain ("Miller") Charge	—	54	81		V _{GS} = 10V ④
t _{d(on)}	Turn-On Delay Time	—	11	—	ns	V _{DD} = 38V
t _r	Rise Time	—	150	—		I _D = 78A
t _{d(off)}	Turn-Off Delay Time	—	150	—		R _G = 2.5Ω
t _f	Fall Time	—	140	—		V _{GS} = 10V ④
L _D	Internal Drain Inductance	—	4.5	—	nH	Between lead, 6mm (0.25in.) from package and center of die contact
L _S	Internal Source Inductance	—	7.5	—		
C _{iss}	Input Capacitance	—	5600	—	pF	V _{GS} = 0V
C _{oss}	Output Capacitance	—	890	—		V _{DS} = 25V
C _{rss}	Reverse Transfer Capacitance	—	190	—		f = 1.0KHz, See Fig. 5
C _{oss}	Output Capacitance	—	5800	—		V _{GS} = 0V, V _{DS} = 1.0V, f = 1.0KHz
C _{oss}	Output Capacitance	—	560	—		V _{GS} = 0V, V _{DS} = 60V, f = 1.0KHz
C _{oss eff.}	Effective Output Capacitance ⑤	—	1100	—		V _{GS} = 0V, V _{DS} = 0V to 60V

Source-Drain Ratings and Characteristics

	Parameter	Min.	Typ.	Max.	Units	Conditions
I _S	Continuous Source Current (Body Diode)	—	—	130⑥	A	MOSFET symbol showing the integral reverse p-n junction diode.
I _{SM}	Pulsed Source Current (Body Diode) ①	—	—	520		
V _{SD}	Diode Forward Voltage	—	—	1.3	V	T _J = 25°C, I _S = 78A, V _{GS} = 0V ④
t _{rr}	Reverse Recovery Time	—	110	170	ns	T _J = 25°C, I _F = 78A
Q _{rr}	Reverse Recovery Charge	—	390	590	nC	di/dt = 100A/μs ④
t _{on}	Forward Turn-On Time	Intrinsic turn-on time is negligible (turn-on is dominated by L _S +L _D)				

Notes:

- ① Repetitive rating; pulse width limited by max. junction temperature. (See fig. 11).
- ② Starting T_J = 25°C, L = 0.13mH
R_G = 25Ω, I_{AS} = 78A. (See Figure 12).
- ③ I_{SD} ≤ 78A, di/dt ≤ 320A/μs, V_{DD} ≤ V_{(BR)DSS},
T_J ≤ 175°C
- ④ Pulse width ≤ 400μs; duty cycle ≤ 2%.

- ⑤ C_{oss eff.} is a fixed capacitance that gives the same charging time as C_{oss} while V_{DS} is rising from 0 to 80% V_{DSS}.
- ⑥ Calculated continuous current based on maximum allowable junction temperature. Package limitation current is 75A.
- ⑦ Limited by T_{Jmax}, see Fig.12a, 12b, 15, 16 for typical repetitive avalanche performance.

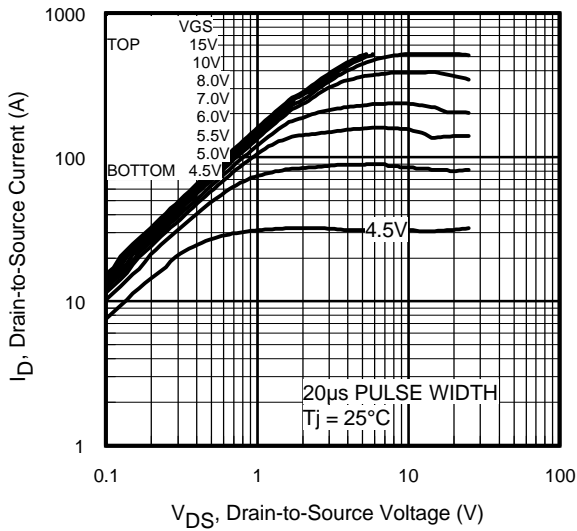

Fig 1. Typical Output Characteristics

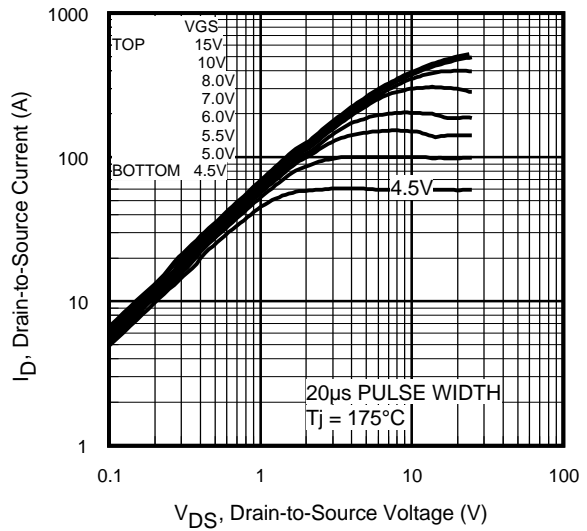

Fig 2. Typical Output Characteristics

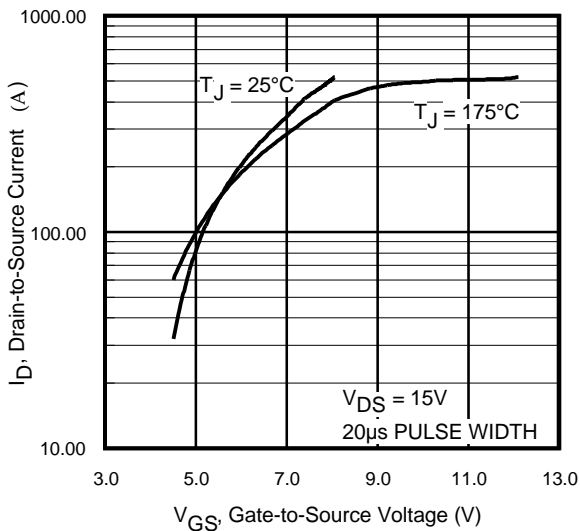

Fig 3. Typical Transfer Characteristics

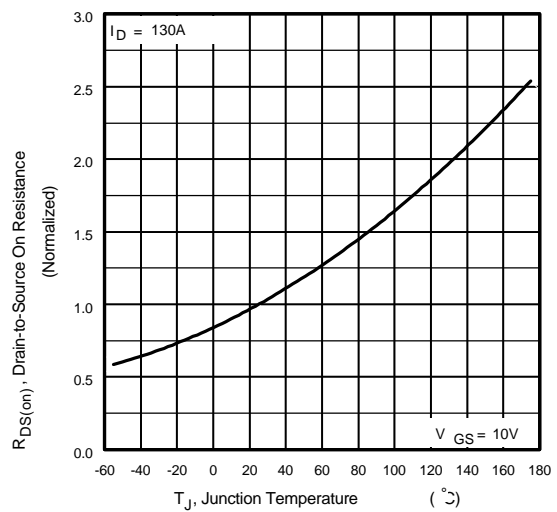

Fig 4. Normalized On-Resistance vs. Temperature

IRF1407

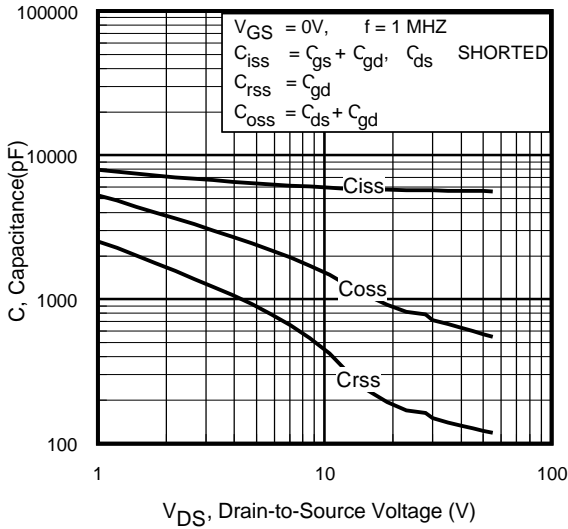

Fig 5. Typical Capacitance vs. Drain-to-Source Voltage

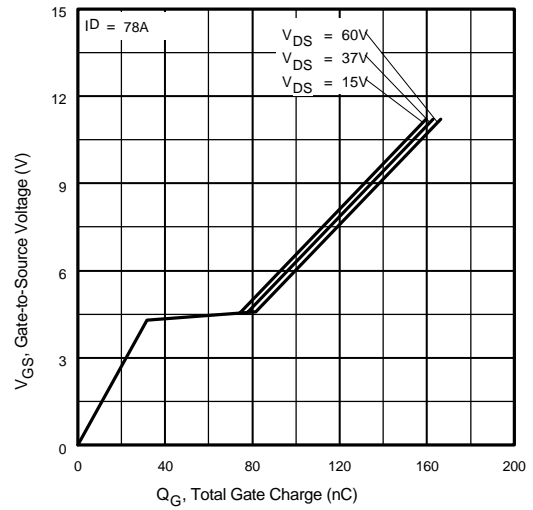

Fig 6. Typical Gate Charge vs. Gate-to-Source Voltage

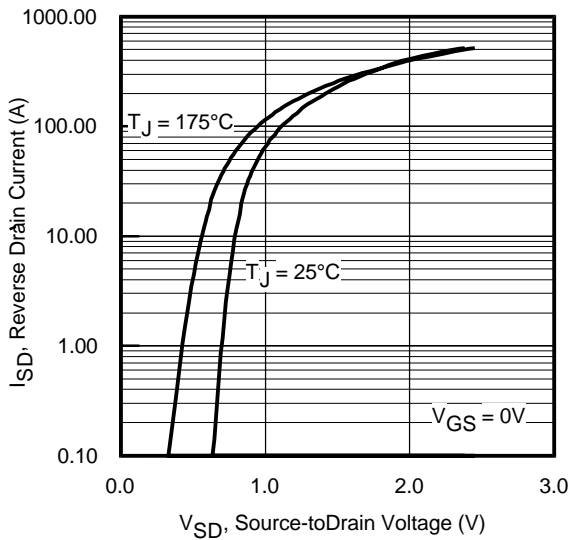

Fig 7. Typical Source-Drain Diode Forward Voltage

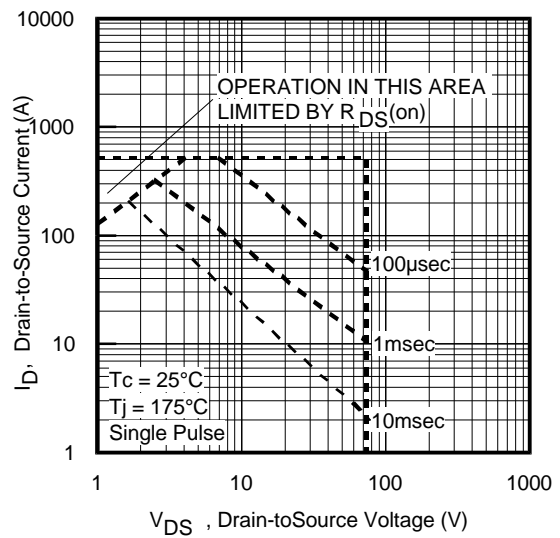

Fig 8. Maximum Safe Operating Area

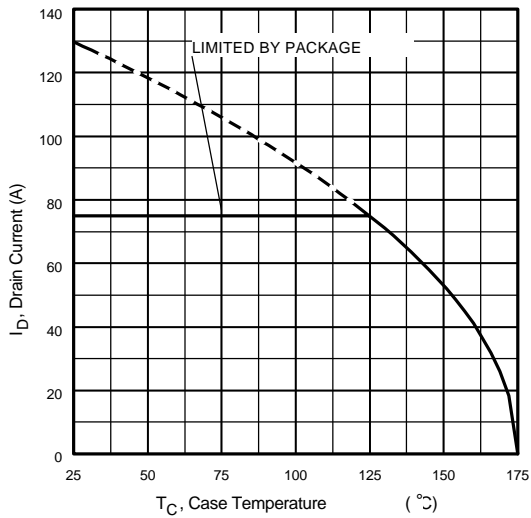

Fig 9. Maximum Drain Current vs. Case Temperature

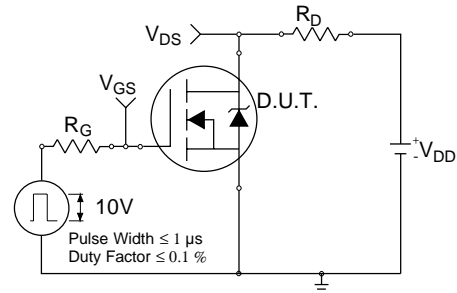

Fig 10a. Switching Time Test Circuit

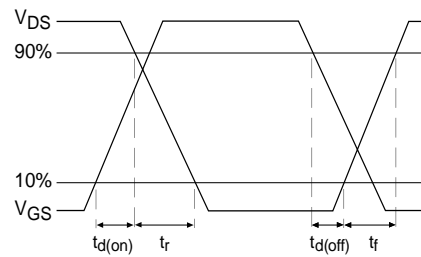

Fig 10b. Switching Time Waveforms

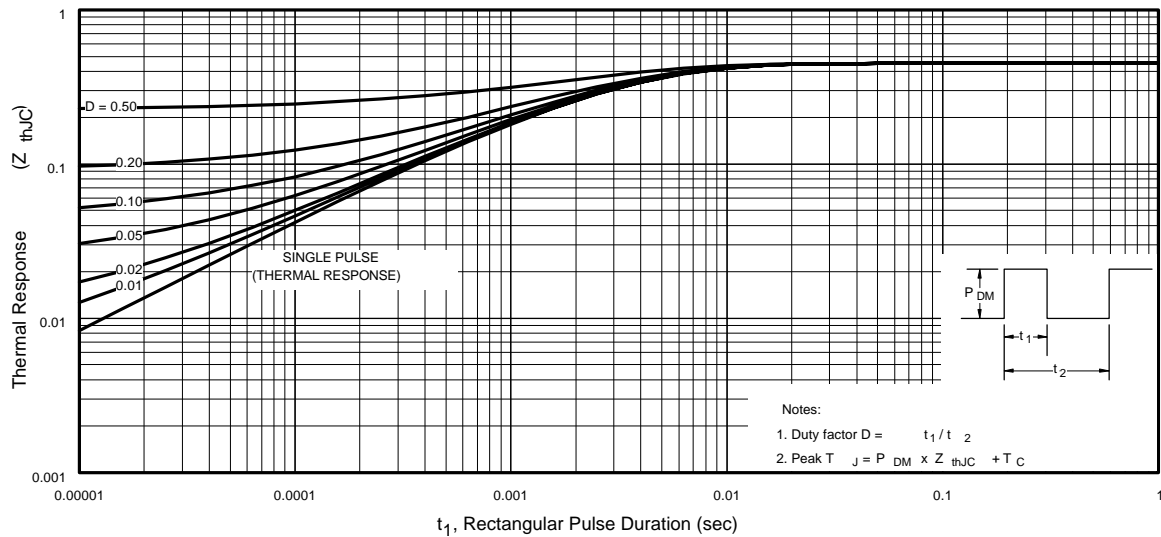

Fig 11. Maximum Effective Transient Thermal Impedance, Junction-to-Case

IRF1407

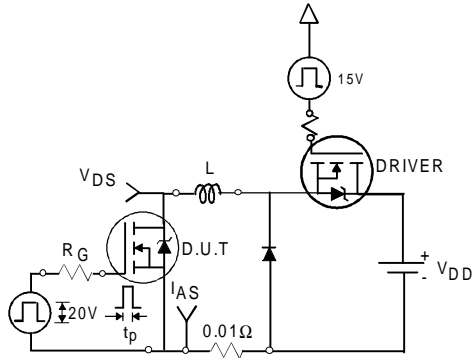

Fig 12a. Unclamped Inductive Test Circuit

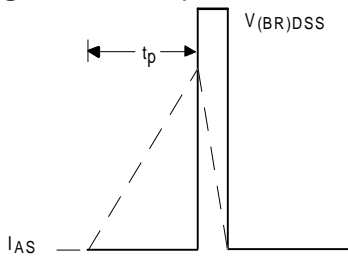

Fig 12b. Unclamped Inductive Waveforms

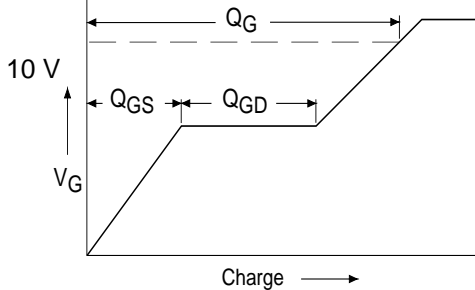

Fig 13a. Basic Gate Charge Waveform

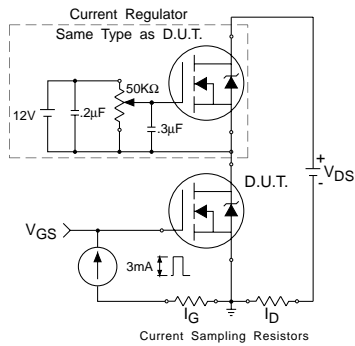

Fig 13b. Gate Charge Test Circuit

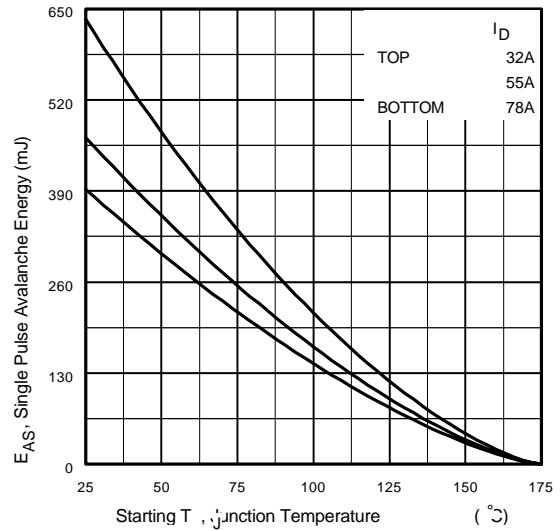

Fig 12c. Maximum Avalanche Energy vs. Drain Current

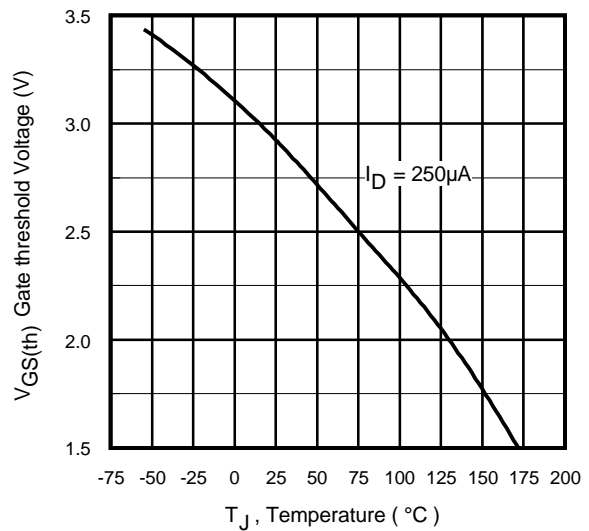

Fig 14. Threshold Voltage vs. Temperature

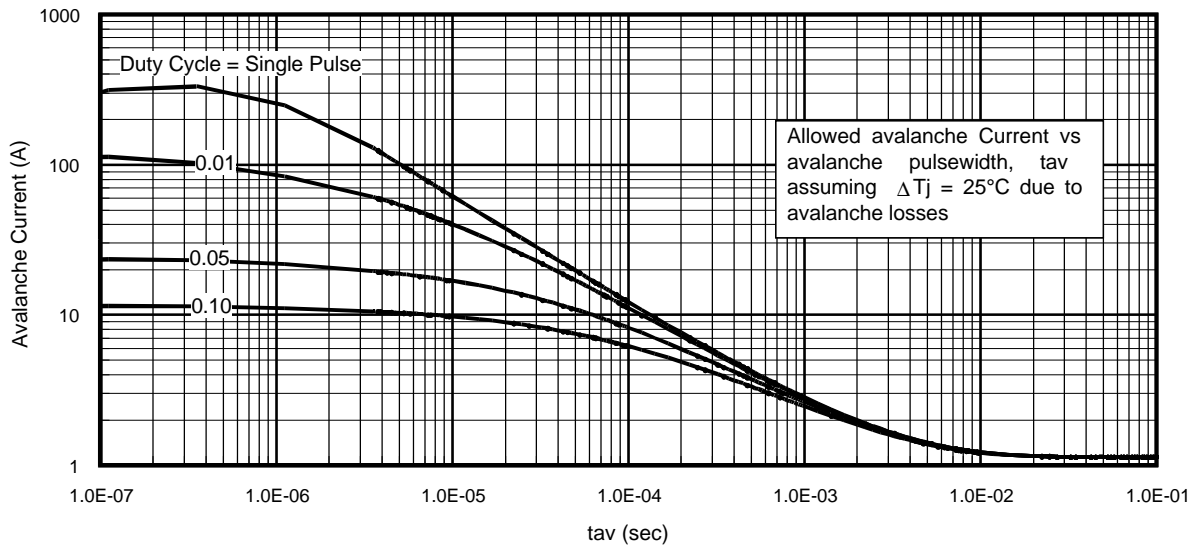

Fig 15. Typical Avalanche Current vs.Pulsewidth

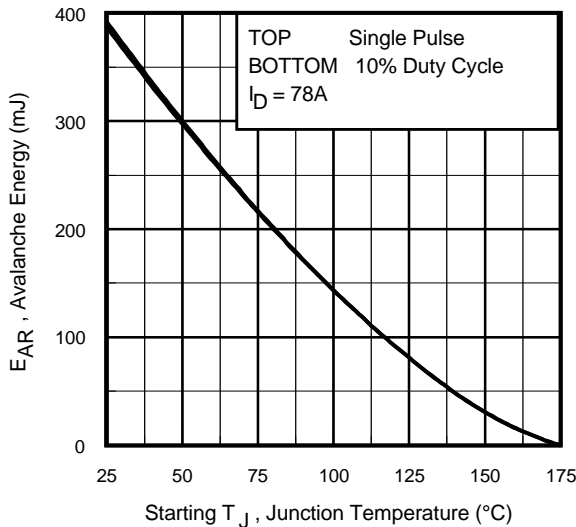

Fig 16. Maximum Avalanche Energy vs. Temperature

**Notes on Repetitive Avalanche Curves , Figures 15, 16:
(For further info, see AN-1005 at www.irf.com)**

1. Avalanche failures assumption:
Purely a thermal phenomenon and failure occurs at a temperature far in excess of T_{jmax} . This is validated for every part type.
2. Safe operation in Avalanche is allowed as long as T_{jmax} is not exceeded.
3. Equation below based on circuit and waveforms shown in Figures 12a, 12b.
4. $P_{D(ave)}$ = Average power dissipation per single avalanche pulse.
5. BV = Rated breakdown voltage (1.3 factor accounts for voltage increase during avalanche).
6. I_{av} = Allowable avalanche current.
7. ΔT = Allowable rise in junction temperature, not to exceed T_{jmax} (assumed as 25°C in Figure 15, 16).
 t_{av} = Average time in avalanche.
 D = Duty cycle in avalanche = $t_{av} \cdot f$
 $Z_{thJC}(D, t_{av})$ = Transient thermal resistance, see figure 11)

$$P_{D(ave)} = 1/2 (1.3 \cdot BV \cdot I_{av}) = \Delta T / Z_{thJC}$$

$$I_{av} = 2\Delta T / [1.3 \cdot BV \cdot Z_{th}]$$

$$E_{AS(AR)} = P_{D(ave)} \cdot t_{av}$$

Peak Diode Recovery dv/dt Test Circuit

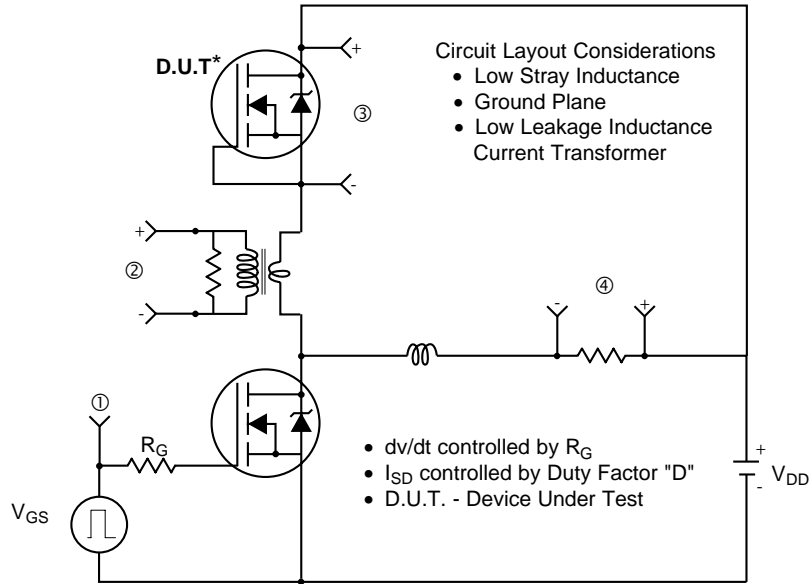

* Reverse Polarity of D.U.T for P-Channel

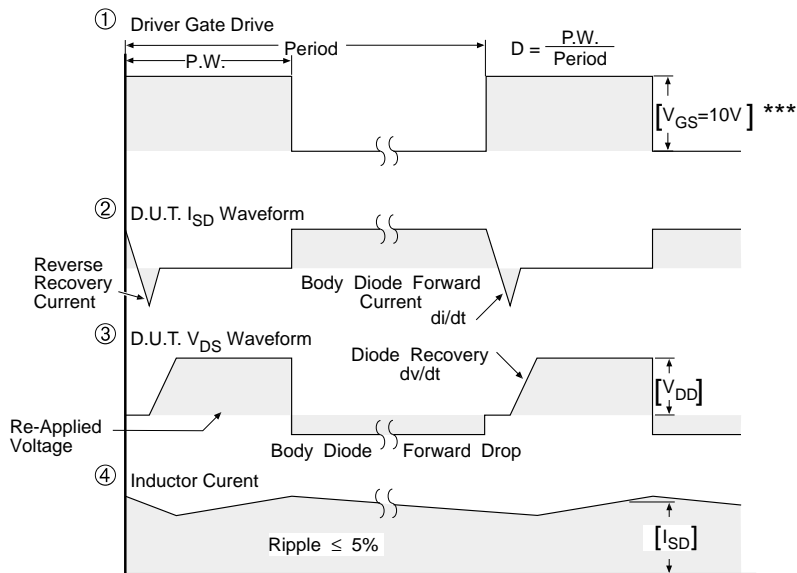

*** $V_{GS} = 5.0V$ for Logic Level and 3V Drive Devices

Fig 17. For N-channel HEXFET® power MOSFETs

TO-220AB Package Outline

Dimensions are shown in millimeters (inches)

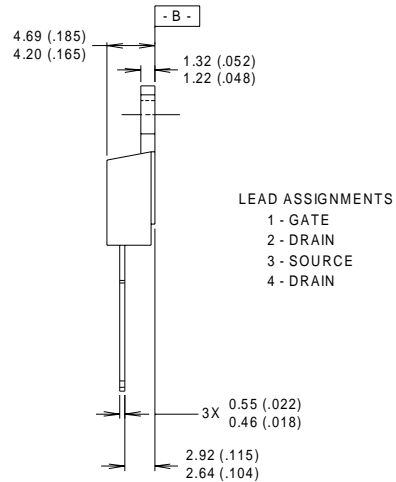
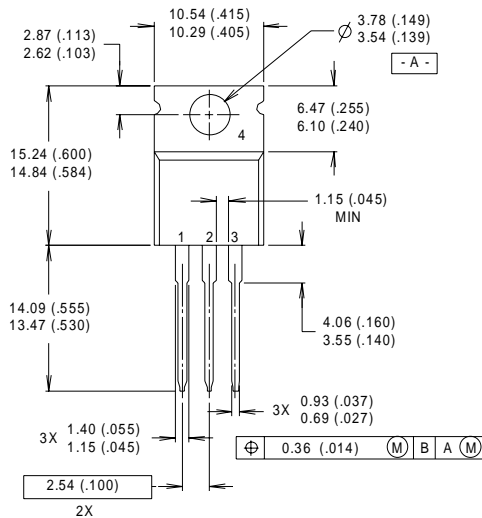

NOTES:

- 1 DIMENSIONING & TOLERANCING PER ANSI Y14.5M, 1982.
- 2 CONTROLLING DIMENSION : INCH

- 3 OUTLINE CONFORMS TO JEDEC OUTLINE TO-220AB.
- 4 HEATSINK & LEAD MEASUREMENTS DO NOT INCLUDE BURRS.

TO-220AB Part Marking Information

EXAMPLE: THIS IS AN IRF1010
 LOT CODE 1789
 ASSEMBLED ON WW 19, 1997
 IN THE ASSEMBLY LINE "C"

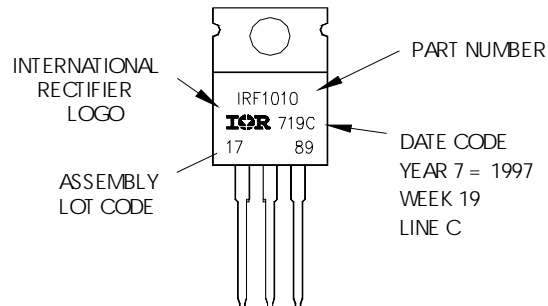

Data and specifications subject to change without notice.
 This product has been designed and qualified for the Automotive [Q101] market.
 Qualification Standards can be found on IR's Web site.

Note: For the most current drawings please refer to the IR website at:
<http://www.irf.com/package/>