



### DEVICE TYPES

Part No.	CTR % Min.	Part No.	CTR % Min.
4N25	20	MCT2	20
4N26	20	MCT2E	20
4N27	10	MCT270	50
4N28	10	MCT271	45-90
4N35	100	MCT272	75-150
4N36	100	MCT273	125-250
4N37	100	MCT274	225-400
4N38	10	MCT275	70-90
H11A1	50	MCT276	15-60
H11A2	20	MCT277	100
H11A3	20		
H11A4	10		
H11A5	30		

### FEATURES

- Interfaces with Common Logic Families
- Input-output Coupling Capacitance < 0.5 pF
- Industry Standard Dual-in-line 6-pin Package
- Field Effect Stable by TRIOS®
- 5300 V<sub>RMS</sub> Isolation Test Voltage
- Underwriters Laboratory File #E52744
- VDE #0884 Approval Available with Option 1

### APPLICATIONS

- AC Mains Detection
- Reed Relay Driving
- Switch Mode Power Supply Feedback
- Telephone Ring Detection
- Logic Ground Isolation
- Logic Coupling with High Frequency Noise Rejection

### Notes:

Designing with data sheet is covered in Application Note 45.

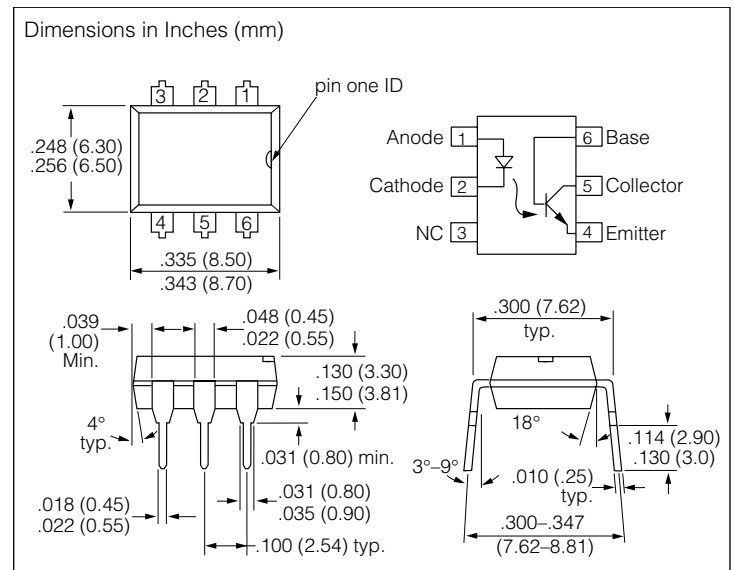

### DESCRIPTION

This data sheet presents five families of Vishay Industry Standard Single Channel Phototransistor Couplers. These families include the 4N25/26/27/28 types, the 4N35/36/37/38 couplers, the H11A1/A2/A3/A4/A5, the MCT2/2E, and MCT270/271/272/273/274/275/276/277 devices. Each optocoupler consists of Gallium Arsenide infrared LED and a silicon NPN phototransistor.

These couplers are Underwriters Laboratories (UL) listed to comply with a 5300 V<sub>RMS</sub> Isolation Test Voltage. This isolation performance is accomplished through Vishay double molding isolation manufacturing process. Compliance to VDE 0884 partial discharge isolation specification is available for these families by ordering option 1. Phototransistor gain stability, in the presence of high isolation voltages, is insured by incorporating a TRansparent IOn Shield (TRIOS)® on the phototransistor substrate. These isolation processes and the Vishay ISO9001 Quality program results in the highest isolation performance available for a commercial plastic phototransistor optocoupler.

The devices are available in lead formed configuration suitable for surface mounting and are available either on tape and reel, or in standard tube shipping containers.

## Maximum Ratings $T_A=25^\circ\text{C}$

### Emitter

Reverse Voltage .....	6.0 V
Forward Current .....	60 mA
Surge Current ( $t \leq 10 \mu\text{s}$ ) .....	2.5 A
Power Dissipation .....	100 mW

### Detector

Collector-Emitter Breakdown Voltage .....	70 V
Emitter-Base Breakdown Voltage .....	7.0 V
Collector Current .....	50 mA
Collector Current ( $t < 1.0 \text{ ms}$ ) .....	100 mA
Power Dissipation .....	150 mW

### Package

Isolation Test Voltage .....	5300 $V_{\text{RMS}}$
Creepage .....	$\geq 7.0 \text{ mm}$
Clearance .....	$\geq 7.0 \text{ mm}$
Isolation Thickness between Emitter and Detector .....	$\geq 0.4 \text{ mm}$
Comparative Tracking Index per DIN IEC 112/VDE0303, part 1 .....	175
Isolation Resistance	
$V_{\text{IO}}=500 \text{ V}, T_A=25^\circ\text{C}$ .....	$10^{12} \Omega$
$V_{\text{IO}}=500 \text{ V}, T_A=100^\circ\text{C}$ .....	$10^{11} \Omega$
Storage Temperature .....	$-55^\circ\text{C}$ to $+150^\circ\text{C}$
Operating Temperature .....	$-55^\circ\text{C}$ to $+100^\circ\text{C}$
Junction Temperature .....	$100^\circ\text{C}$
Soldering Temperature (max. 10 s, dip soldering: distance to seating plane $\geq 1.5 \text{ mm}$ ) .....	$260^\circ\text{C}$

## 4N25/26/27/28—Characteristics $T_A=25^\circ\text{C}$

Emitter		Symbol	Min.	Typ.	Max.	Unit	Condition
Forward Voltage*		$V_F$	—	1.3	1.5	V	$I_F=50 \text{ mA}$
Reverse Current*		$I_R$	—	0.1	100	$\mu\text{A}$	$V_R=3.0 \text{ V}$
Capacitance		$C_O$	—	25	—	pF	$V_R=0$
Detector							
Breakdown Voltage*	Collector-Emitter	$BV_{\text{CEO}}$	30	—	—	V	$I_C=1.0 \text{ mA}$
	Emitter-Collector	$BV_{\text{ECO}}$	7.0	—	—		$I_E=100 \mu\text{A}$
	Collector-Base	$BV_{\text{CBO}}$	70	—	—		$I_C=100 \mu\text{A}$
$I_{\text{CEO}}(\text{dark})^*$	4N25/26/27 4N28	—	—	5.0 10	50 100	nA	$V_{\text{CE}}=10 \text{ V}$ , (base open)
$I_{\text{CBO}}(\text{dark})^*$		—	—	2.0	20	nA	$V_{\text{CB}}=10 \text{ V}$ , (emitter open)
Capacitance, Collector-Emitter		$C_{\text{CE}}$	—	6.0	—	pF	$V_{\text{CE}}=0$
Package							
DC Current Transfer Ratio*	4N25/26	CTR	20	50	—	%	$V_{\text{CE}}=10 \text{ V}$ , $I_F=10 \text{ mA}$
	4N27/28		10	30	—		
Isolation Voltage*	4N25	$V_{\text{IO}}$	2500	—	—	V	Peak, 60 Hz
	4N26/27		1500	—	—		
	4N28		500	—	—		
Saturation Voltage, Collector-Emitter		$V_{\text{CE(sat)}}$	—	—	0.5	V	$I_{\text{CE}}=2.0 \text{ mA}$ , $I_F=50 \text{ mA}$
Resistance, Input to Output*		$R_{\text{IO}}$	100	—	—	$\text{G}\Omega$	$V_{\text{IO}}=500 \text{ V}$
Coupling Capacitance		$C_{\text{IO}}$	—	0.5	—	pF	$f=1.0 \text{ MHz}$
Rise and Fall Times		$t_r, t_f$	—	2.0	—	$\mu\text{s}$	$I_F=10 \text{ mA}$ $V_{\text{CE}}=10 \text{ V}$ , $R_L=100 \Omega$

\* Indicates JEDEC registered values

**4N35/36/37/38—Characteristics  $T_A=25^\circ\text{C}$** 

Emitter		Symbol	Min.	Typ.	Max.	Unit	Condition
Forward Voltage*		$V_F$	0.9	1.3	1.5 1.7	V	$I_F=10\text{ mA}$ $I_F=10\text{ mA}, T_A=-55^\circ\text{C}$
Reverse Current*		$I_R$		0.1	10	$\mu\text{A}$	$V_R=6.0\text{ V}$
Capacitance		$C_O$		25	—	pF	$V_R=0, f=1.0\text{ MHz}$
Detector							
Breakdown Voltage, Collector-Emitter*	4N35/36/37	$BV_{CEO}$	30	—	—	V	$I_C=1.0\text{ mA}$
	4N38		80	—	—		
Breakdown Voltage, Emitter-Collector*		$BV_{ECO}$	7.0	—	—	V	$I_E=100\ \mu\text{A}$
Breakdown Voltage, Collector-Base*	4N35/36/37	$BV_{CBO}$	70	—	—	V	$I_C=100\ \mu\text{A}, I_B=1.0\ \mu\text{A}$
	4N38		80	—	—	—	
Leakage Current, Collector-Emitter*	4N35/36/37	$I_{CEO}$	—	5.0	50	nA	$V_{CE}=10\text{ V}, I_F=0$
	4N38		—	—	50		$V_{CE}=60\text{ V}, I_F=0$
Leakage Current, Collector-Emitter*	4N35/36/37	$I_{CEO}$	—	—	500	$\mu\text{A}$	$V_{CE}=30\text{ V}, I_F=0, T_A=100^\circ\text{C}$
	4N38		—	6.0	—		$V_{CE}=60\text{ V}, I_F=0, T_A=100^\circ\text{C}$
Capacitance, Collector-Emitter		$C_{CE}$	—	6.0	—	pF	$V_{CE}=0$
Package							
DC Current Transfer Ratio*	4N35/36/37	CTR	100	—	—	%	$V_{CE}=10\text{ V}, I_F=10\text{ mA},$
	4N38		20	—	—		$V_{CE}=1.0\text{ V}, I_F=20\text{ mA}$
DC Current Transfer Ratio*	4N35/36/37	CTR	40	50	—	%	$V_{CE}=10\text{ V}, I_F=10\text{ mA},$ $T_A=-55\text{ to }100^\circ\text{C}$
	4N38	—	—	30	—		
Resistance, Input to Output*		$R_{IO}$	$10^{11}$	—	—	$\Omega$	$V_{IO}=500\text{ V}$
Coupling Capacitance		$C_{IO}$	—	0.5	—	pF	$f=1.0\text{ MHz}$
Switching Time*		$t_{ON}, t_{OFF}$	—	10	—	$\mu\text{s}$	$I_C=2.0\text{ mA}, R_L=100\ \Omega, V_{CC}=10\text{ V}$

\* Indicates JEDEC registered value

**H11A1 through H11A5—Characteristics  $T_A=25^\circ\text{C}$** 

Emitter		Symbol	Min.	Typ.	Max.	Unit	Condition
Forward Voltage	H11A1–H11A4	$V_F$	—	1.1	1.5	V	$I_F=10\text{ mA}$
	H11A5		—	1.1	1.7		
Reverse Current		$I_R$	—	—	10	$\mu\text{A}$	$V_R=3.0\text{ V}$
Capacitance		$C_O$	—	50	—	pF	$V_R=0, f=1.0\text{ MHz}$
Detector							
Breakdown Voltage, Collector-Emitter		$BV_{CEO}$	30	—	—	V	$I_C=1.0\text{ mA}, I_F=0\text{ mA}$
Breakdown Voltage, Emitter-Collector		$BV_{ECO}$	7.0	—	—	V	$I_E=100\ \mu\text{A}, I_F=0\text{ mA}$
Breakdown Voltage, Collector-Base		$BV_{CBO}$	70	—	—	V	$I_C=10\ \mu\text{A}, I_F=0\text{ mA}$
Leakage Current, Collector-Emitter		$I_{CEO}$	—	5.0	50	nA	$V_{CE}=10\text{ V}, I_F=0\text{ mA}$
Capacitance, Collector-Emitter		$C_{CE}$	—	6.0	—	pF	$V_{CE}=0$
Package							
DC Current Transfer Ratio	H11A1	CTR	50	—	—	%	$V_{CE}=10\text{ V}, I_F=10\text{ mA}$
	H11A2/3		20	—	—		
	H11A4		10	—	—		
	H11A5		30	—	—		
Saturation Voltage, Collector-Emitter		$V_{CESat}$	—	—	0.4	V	$I_{CE}=0.5\text{ mA}, I_F=10\text{ mA}$
Capacitance, Input to Output		$C_{IO}$	—	0.5	—	pF	—
Switching Time		$t_{ON}, t_{OFF}$	—	3.0	—	$\mu\text{s}$	$I_C=2.0\text{ mA}, R_L=100\ \Omega, V_{CE}=10\text{ V}$

**MCT2/MCT2E—Characteristics  $T_A=25^\circ\text{C}$** 

Emitter		Symbol	Min.	Typ.	Max.	Unit	Condition
Forward Voltage		$V_F$	—	1.1	1.5	V	$I_F=20\text{ mA}$
Reverse Current		$I_R$	—	—	10	$\mu\text{A}$	$V_R=3.0\text{ V}$
Capacitance		$C_O$	—	25	—	pF	$V_R=0, f=1.0\text{ MHz}$
Detector							
Breakdown Voltage	Collector-Emitter	$BV_{CEO}$	30	—	—	V	$I_C=1.0\text{ mA}, I_F=0\text{ mA}$
	Emitter-Collector	$BV_{ECO}$	7.0	—	—		$I_E=100\ \mu\text{A}, I_F=0\text{ mA}$
	Collector-Base	$BV_{CBO}$	70	—	—		$I_C=10\ \mu\text{A}, I_F=0\text{ mA}$
Leakage Current	Collector-Emitter	$I_{CBO}$	—	5.0	50	nA	$V_{CE}=10\text{ V}, I_F=0$
	Collector-Base	$I_{CBO}$	—	—	20		
Capacitance, Collector-Emitter	—	$C_{CE}$	—	10	—	pF	$V_{CE}=0$
Package							
DC Current Transfer Ratio		CTR	20	60	—	%	$V_{CE}=10\text{ V}, I_F=10\text{ mA}$
Capacitance, Input to Output		$C_{IO}$	—	0.5	—	pF	—
Resistance, Input to Output		$R_{IO}$	—	100	—	$\text{G}\Omega$	—
Switching Time		$t_{ON}, t_{OFF}$	—	3.0	—	$\mu\text{s}$	$I_C=2.0\text{ mA}, R_L=100\ \Omega, V_{CE}=10\text{ V}$

**MCT270 through MCT277—Characteristics  $T_A=25^\circ\text{C}$** 

Emitter		Symbol	Min.	Typ.	Max.	Unit	Condition
Forward Voltage		$V_F$	—	—	1.5	V	$I_F=20\text{ mA}$
Reverse Current		$I_R$	—	—	10	$\mu\text{A}$	$V_R=3.0\text{ V}$
Capacitance		$C_O$	—	25	—	pF	$V_R=0, f=1.0\text{ MHz}$
Detector							
Breakdown Voltage	Collector-Emitter	$BV_{CEO}$	30	—	—	V	$I_C=10\ \mu\text{A}, I_F=0\text{ mA}$
	Emitter-Collector	$BV_{ECO}$	7.0	—	—		$I_E=10\ \mu\text{A}, I_F=0\text{ mA}$
	Collector-Base	$BV_{CBO}$	70	—	—		$I_C=10\ \mu\text{A}, I_F=0\text{ mA}$
Leakage Current, Collector-Emitter		$I_{CEO}$	—	—	50	nA	$V_{CE}=10\text{ V}, I_F=0\text{ mA}$
Package							
DC Current Transfer Ratio	MCT270	CTR	50	—	—	%	$V_{CE}=10\text{ V}, I_F=10\text{ mA}$
	MCT271		45	—	90		
	MCT272		75	—	150		
	MCT273		125	—	250		
	MCT274		225	—	400		
	MCT275		70	—	210		
	MCT276		15	—	60		
	MCT277		100	—	—		
Current Transfer Ratio, Collector-Emitter	MCT271–276	$CTR_{CE}$	12.5	—	—	%	$V_{CE}=0.4\text{ V}, I_F=16\text{ mA}$
	MCT277		40	—	—		
Collector-Emitter Saturation Voltage		$V_{CEsat}$	—	—	0.4	V	$I_{CE}=2.0\text{ mA}, I_F=16\text{ mA}$
Capacitance, Input to Output		$C_{IO}$	—	0.5	—	pF	—
Resistance, Input to Output		$R_{IO}$	—	$10^{12}$	—	$\Omega$	$V_{IO}=500\text{ VDC}$
Switching Time	MCT270/272	$t_{ON}, t_{OFF}$	—	—	10	$\mu\text{s}$	$I_C=2.0\text{ mA}, R_L=100\ \Omega, V_{CE}=5.0\text{ V}$
	MCT271		—	—	7.0		
	MCT273		—	—	20		
	MCT274		—	—	25		
	MCT275/277		—	—	15		
	MCT276		—	—	3.5		

Figure 1. Forward Voltage vs. Forward Current

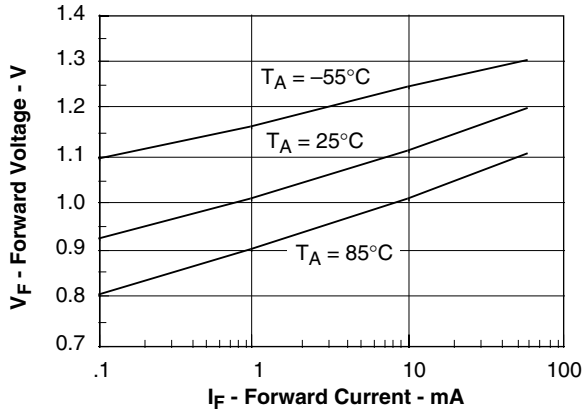

Figure 4. Normalized Non-saturated and Saturated CTR, T<sub>A</sub>=70°C vs. LED Current

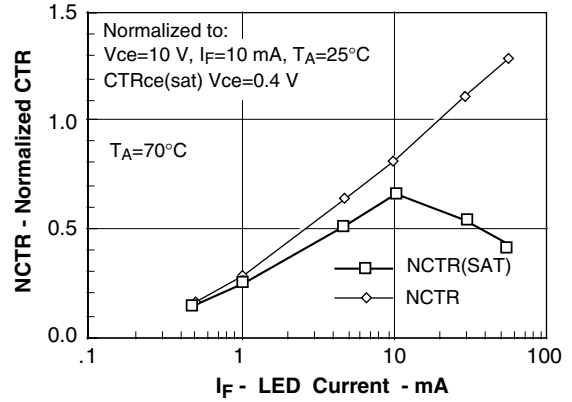

Figure 2. Normalized Non-saturated and Saturated CTR, T<sub>A</sub>=25°C vs. LED Current

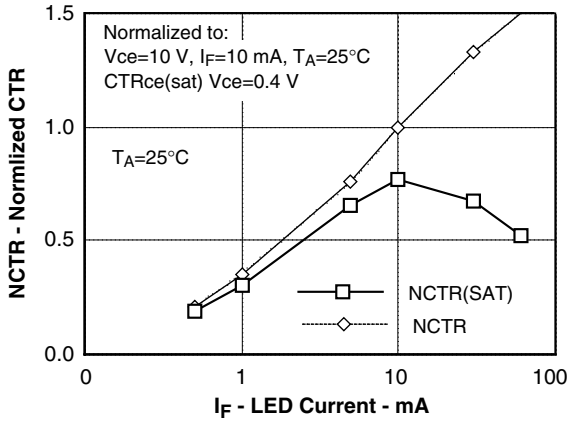

Figure 5. Normalized Non-saturated and Saturated CTR, T<sub>A</sub>=85°C vs. LED Current

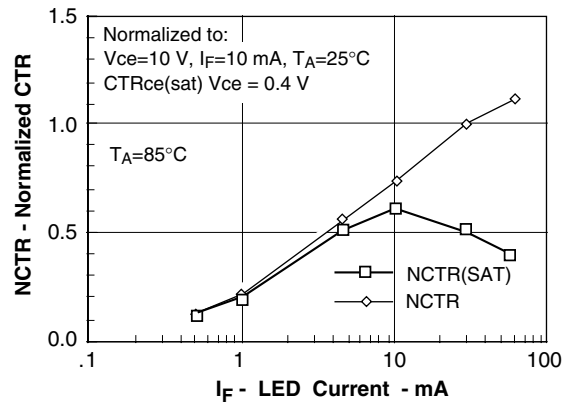

Figure 3. Normalized Non-saturated and Saturated CTR, T<sub>A</sub>=50°C vs. LED Current

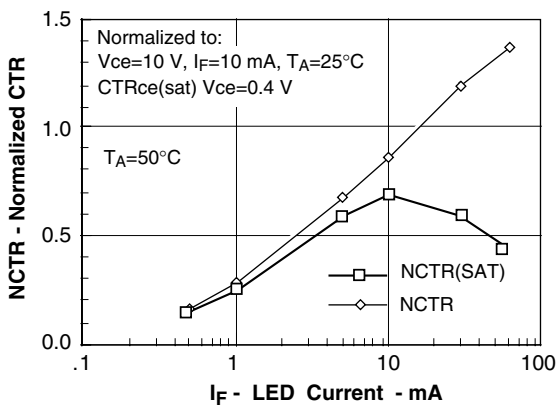

Figure 6. Collector-emitter Current vs. Temperature and LED Current

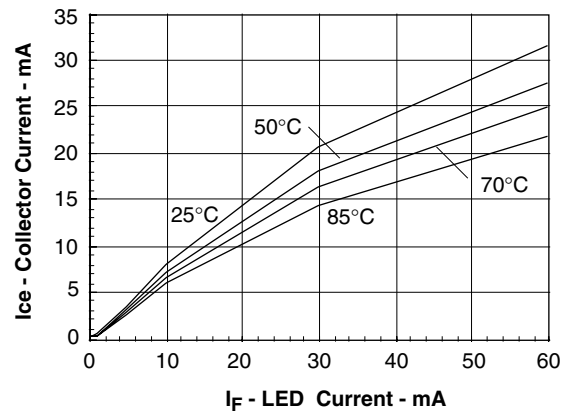

Figure 7. Collector-emitter Leakage Current vs. Temp.

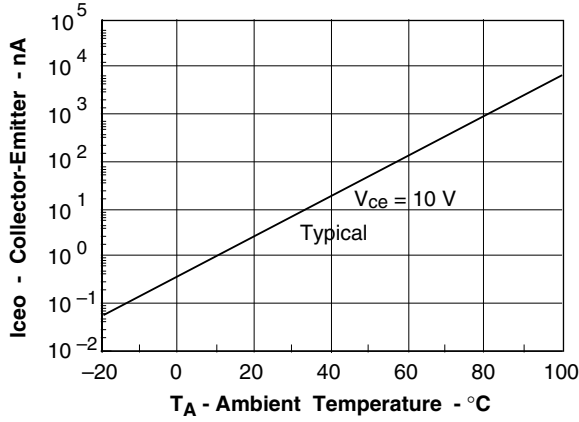

Figure 8. Normalized CTRcb vs. LED Current and Temp.

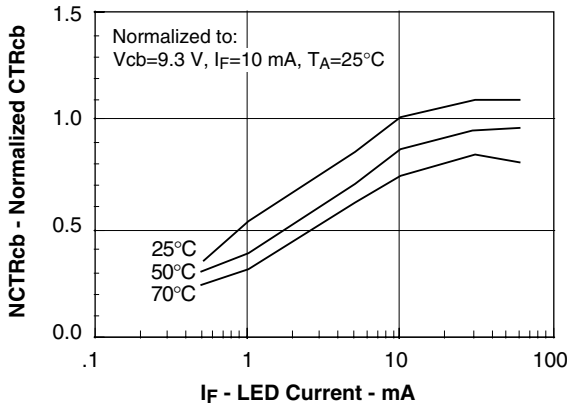

Figure 9. Normalized Photocurrent vs. I\_F and Temp.

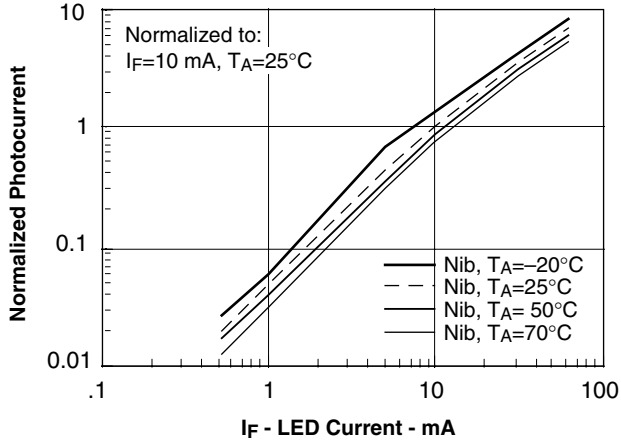

Figure 13. Switching Timing

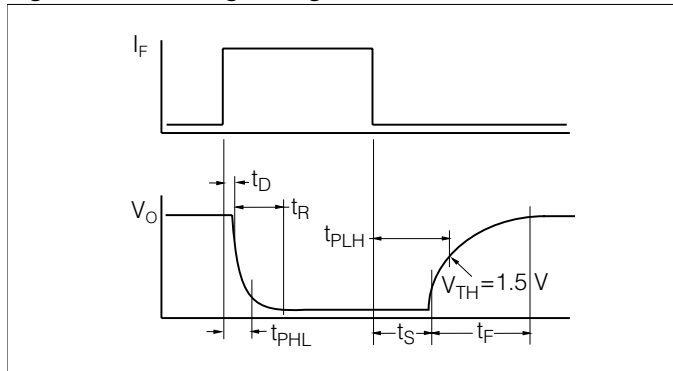

Figure 10. Normalized Non-saturated HFE vs. Base Current and Temperature

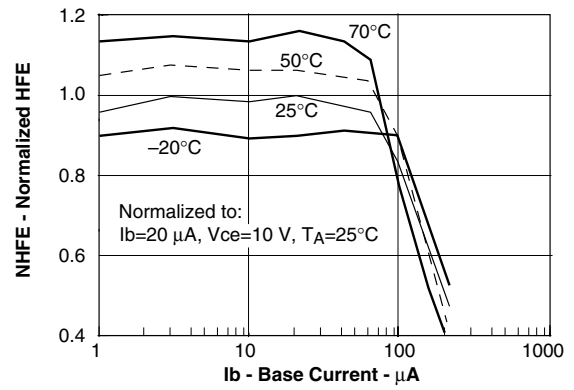

Figure 11. Normalized HFE vs. Base Current and Temp.

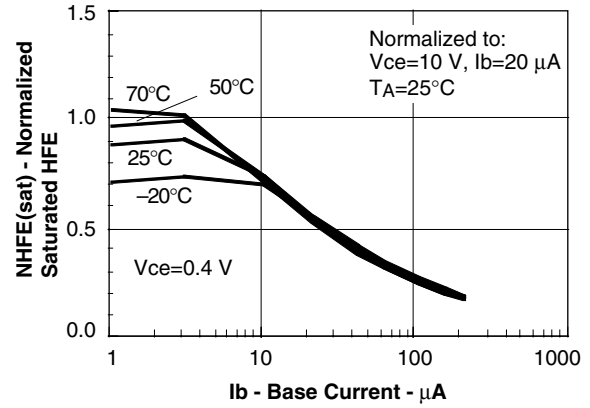

Figure 12. Propagation Delay vs. Collector Load Resistor

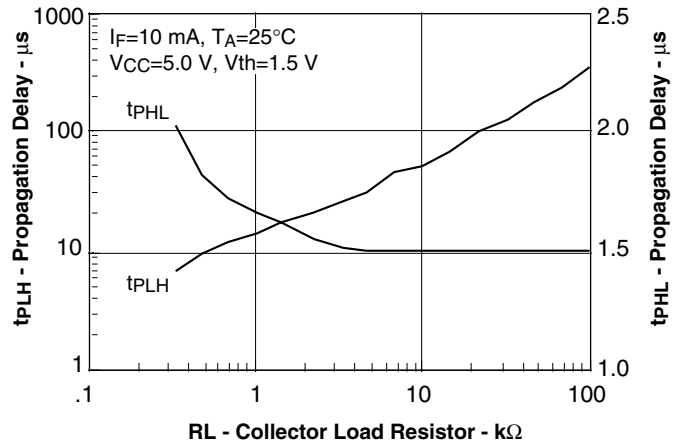
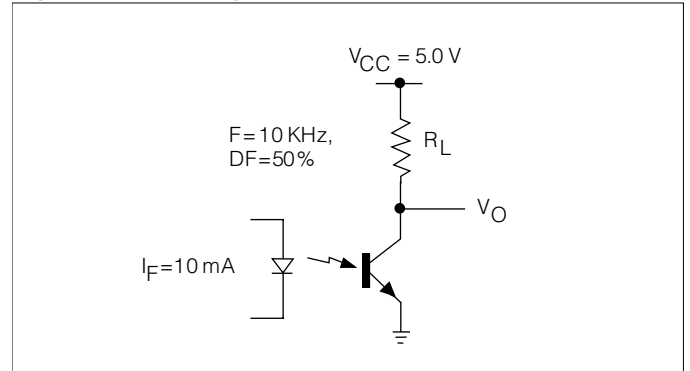

Figure 14. Switching Schematic



This datasheet has been download from:

[www.datasheetcatalog.com](http://www.datasheetcatalog.com)

Datasheets for electronics components.