



Dioda Zenera BZP630 C13V;0.25W;CEMI



Dane techniczne:

Nazwa: BZP630

Typ: dioda Zenera

Napięcie: 13V

Moc: 0.25W

Diody Zenera to diody stabilizacyjne, stosowane są do przesuwania poziomów napięć, a także jako element pełniący funkcję zabezpieczenia i działania przeciw przepięciom.

1. DIODY I TYRYSTORY

Wykaz oznaczeń parametrów technicznych

C_r	pojemność diody przy określonym napięciu wstecznym
$\frac{C_r/U_{R1}}{C_r/U_{R2}}$	stosunek pojemności
$\frac{di_T}{dt}$	krytyczna stromość narastania prądu przewodzenia
f_p	częstotliwość pomiarowa
I_F	prąd przewodzenia
I_{FM}	szczytowy prąd przewodzenia
I_{FRM}	powtarzalny szczytowy prąd przewodzenia
I_{FSM}	niepowtarzalny szczytowy prąd przewodzenia
I_G	prąd bramki
I_{GT}	przełączający prąd bramki
I_O	średni prąd wyprostowany
I_R	prąd wsteczny
i_{rr}	prąd ustalenia charakterystyki wstecznej
I_T	skuteczny prąd przewodzenia tyrystora
$I_{T/AV/}$	średni prąd przewodzenia tyrystora
$I_{T/RMS/}$	skuteczny prąd przewodzenia tyrystora
I_{TSM}	niepowtarzalny szczytowy prąd przewodzenia tyrystora
I_Z	prąd stabilizacji
P_{tot}	moc całkowita
P_{GM}	straty mocy w bramce
Q	dobroć
r_F	rezystancja dynamiczna w kierunku przewodzenia
r_s	rezystancja szeregową
r_Z	rezystancja dynamiczna
R_L	rezystancja obciążenia
t	czas trwania impulsu
t_{amb}	temperatura otoczenia
t_{case}	temperatura obudowy
t_j	temperatura złącza
t_r	czas narastania
t_{rr}	czas ustalania charakterystyki wstecznej
U_D	napięcie blokowania
U_{DRM}	powtarzalne szczytowe napięcie blokowania

U_{DSN}	niepowtarzalne szczytowe napięcie blokowania
U_F	napięcie przewodzenia diody
U_{FSM}	niepowtarzalne szczytowe napięcie przewodzenia
U_{GT}	napięcie przełączające bramki
U_R	napięcie wsteczne
U_{RM}	szczytowe napięcie wsteczne
U_{RRM}	powtarzalne szczytowe napięcie wsteczne
U_{RSM}	niepowtarzalne szczytowe napięcie wsteczne
U_{RWM}	szczytowe napięcie wsteczne pracy
U_T	napięcie przewodzenia tyrystora
U_Z	napięcie stabilizacji
α_{UF}	współczynnik temperatury stabilizacji w kierunku przewodzenia
α_{UZ}	współczynnik temperaturowy napięcia stabilizacji
θ	kąt przepływu

KOD BARWNY NA OBUDOWACH DIOD

OBUDOWA CE 02 /DO 35/

dioda	pasek / pasek	
BAVP 10	brązowy	/ czarny
BAVP 17	brązowy	/ fioletowy
BAVP 18	brązowy	/ szary
BAVP 19	brązowy	/ biały
BAVP 20	czerwony	/ czarny
BAVP 21	czerwony	/ brązowy
BAVP 61	żółty	/ brązowy
BAVP 94	brązowy	
BAVP 94A	czerwony	
BAVP 95	pomarańczowy	
BAVP 95A	żółty	

diody Zenera BZP 683

kolor pasków	1	2	3	4
czarny	-	0	x1	
brązowy	1	1		
czerwony	2	2		
pomarańczowy	3	3		
żółty	4	4		
zielony	5	5		
niebieski	6	6		
fioletowy	7	7		
szary	8	8		
biały	9	9	x10 ⁻¹	
złoty	-	-	-	5% /C/
srebrny	-	-	-	10% /D/

OBUDOWA CE 31

dioda	pasek / pasek	
BA 157	czerwony	/ czerwony
BA 158	biały	/ biały
BA 159	zielony	/ zielony

dioda trzy paski

BYP 150	- 50	niebieskie
	- 100	szare
	- 225	żółte
	- 300	zielone
	- 400	czerwone
	- 600	białe

dioda pasek

BYP 401	- 50	szary
	- 100	czerwony
	- 200	żółty
	- 400	zielony
	- 600	niebieski
	- 800	biały
	-1000	brązowy

OBUDOWA CE 37 /SOD 23/

dioda	kropka	/ pasek
BA 182	czerwona	
BA 152P	czarna	
BAP 794	żółta	
BAP 794A	pomarańczowa	
BAP 795	niebieska	
BAP 795A	szara	
BB 105A	biała	
BB 105B	biała	/ biały
BB 105G	zielona	
BB 109	czarna	/ żółty

1.1. Diody prostownicze

BY

Oznaczenie wyrobu	Parametry graniczne / $t_{amb} = 25^{\circ}\text{C}$ /										Parametry charakterystyczne / $t_{amb} = 25^{\circ}\text{C}$ /						Zastosowanie	Obudowa
	U_{RWM} V	U_{RSM} / U_{RSM} V	I_o / I_F A	I_{FSM} przy		t_j ms	t_j $^{\circ}\text{C}$	t_{amb} $^{\circ}\text{C}$	t_{stg} $^{\circ}\text{C}$	U_F przy		I_R przy		U_R V				
				I_{FSM}	t_j					V	max	A	μA		max			
	max	max	max	max	max	max	max	max	max	max	max	max	max					
1	2	3	4	5	6	7	8	9	10	11	12	13	14	15	16			
BYP 150-50	50	100						-40 ... +85					50					
BYP 150-100	100	200						-40 ... +85					100					
BYP 150-225	225	350						-40 ... +85					225					
BYP 150-300	300	400	0,4	15		150		-40 ... +85		1,5	1	5	300	a	CE 31			
BYP 150-400	400	600						-40 ... +85					400					
BYP 150-600	600	800						-40 ... +85					600					
BYP 155-350 ^x	300	/350/	/1,2/	40	150	10	150	-40 ... +100		1,25	5	750		d	xx			
BYP 155-600 ^x	500	/600/	/1,2/	40	150	10	150	-40 ... +100		1,25	5	750		d	xx			
BYP 350-2 k		/2 k/	/0,008/	1	10	100	100	-40 ... +100		30	0,01	10	2 k	c	CE 08			
BYP 350-8 k		/8 k/	/0,008/	1	10	100	100	-40 ... +100		30	0,01	10	8 k	c	CE 08			
BYP 350-12 k		/12 k/	/0,008/	1	10	100	100	-40 ... +100		37,5	0,01	10	12 k	c	CE 08			
BYP 350-16 k		/16 k/	/0,008/	1	10	100	100	-40 ... +100		50	0,01	10	16 k	c	CE 08			
BYP 401-50	50	100						-40 ... +100					50					
BYP 401-100	100	200						-40 ... +100					100					
BYP 401-200	200	400						-40 ... +100					200					
BYP 401-400	400	600	1	50		150		-40 ... +100		1,1	1	5	400	a	CE 31			
BYP 401-600	600	800						-40 ... +100					600					
BYP 401-800	800	1000						-40 ... +100					800					
BYP 401-1000	1000	1300						-40 ... +100					1000					
BYP 671-350 ^x	300	/350/	/5,1/	60	150	10	150			1,25	5	200 ² /		d	CE 30 ^{xx}			
BYP 671-350 R ^x																		
BYP 671-600 ^x	500	/600/	/5,1/	60	150	10	150			1,25	5	200 ² /		d	CE 30 ^{xx}			
BYP 671-600 R ^x																		

1	2	3	4	5	6	7	8	9	10	11	12	13	14	15	16
BYP 680-50	50	80	5	60	150	10	150	-40 ... +85	-55 ... +100	1,3	5	50	50	b	CE 11
BYP 680-50 R															
BYP 680-100	100	160	5	60	150	10	150	-40 ... +85	-55 ... +100	1,3	5	50	100	b	CE 11
BYP 680-100 R															
BYP 680-300	300	500	5	60	150	10	150	-40 ... +85	-55 ... +100	1,3	5	50	300	b	CE 11
BYP 680-300 R															
BYP 680-500	500	800	5	60	150	10	150	-40 ... +85	-55 ... +100	1,3	5	50	500	b	CE 11
BYP 680-500 R															
BYP 680-600	600	1000	5	60	150	10	150	-40 ... +85	-55 ... +100	1,3/	5	50	600	b	CE 11
BYP 680-600 R															

a prostowniki do 1 A

b prostowniki do 5 A

c powielacze napięcia do OTV

d szybkie przełączniki

x nowe uruchomienia

xx obudowa w opracowaniu

1/ $t_{amb} = +85^{\circ}C$

2/ $t_{amb} = +100^{\circ}C$

1.2. Diody prostownicze specjalne

BY spec

Oznaczenie wyrobu	Parametry graniczne / $t_{amb} = 25^{\circ}C/$						Parametry charakterystyczne / $t_{amb} = 25^{\circ}C/$						Zastosowanie	Obudowa	
	U_{RWM}	U_{RSM}	I_o	I_{RSM} przy	t_j		t_j	t	t_j	t_j	I_R przy				U_R
					$^{\circ}C$	ms					μA	V			
	max	max	max	max	max	max	max	max	max	max	max	max			
2	3	4	5	6	7	8	9	10	11	12	13	14			
BYAP 80-50	50	80	5	60	150	150	10	150	150	1,3	5	50	50	a	CE 11
BYAP 80-50 R															
BYAP 80-100	100	160	5	60	150	150	10	150	150	1,3	5	50	100	a	CE 11
BYAP 80-100 R															
BYAP 80-300	300	500	5	60	150	150	10	150	150	1,3	5	50	300	a	CE 11
BYAP 80-300 R															
BYAP 80-500	500	800	5	60	150	150	10	150	150	1,3	5	50	500	a	CE 11
BYAP 80-500 R															
BYAP 80-600	600	1000	5	60	150	150	10	150	150	1,3	5	50	600	a	CE 11
BYAP 80-600 R															
BYBP 10-50	50	100	1	50	175	175	10	175	175	1,1	1	5	50	b	CE 31
BYBP 10-100	100	200	1	50	175	175	10	175	175	1,1	1	5	100	b	CE 31
BYBP 10-200	200	400	1	50	175	175	10	175	175	1,1	1	5	200	b	CE 31
BYBP 10-400	400	600	1	50	175	175	10	175	175	1,1	1	5	400	b	CE 31
BYBP 10-600	600	800	1	50	175	175	10	175	175	1,1	1	5	600	b	CE 31
BYBP 10-800	800	1000	1	50	175	175	10	175	175	1,1	1	5	800	b	CE 31
BYBP 10-1000	1000	1300	1	50	175	175	10	175	175	1,1	1	5	1000	b	CE 31

a prostowniki do 5 A

b prostowniki do 1 A

1.3. Diody przełączające

BA

Oznaczenie wyrobu	Parametry graniczne / t _{amb} = 25°C/										Parametry charakterystyczne / t _{amb} = 25°C/										Za- sto- sowa- nie	Obudo- wa
	U _R	U _{RM} /U _{RRM}	I _F	I _{FM} /I _{FRM}	P _{tot}	t _j	t _{amb}	t _{stg}	U _F przy		I _R przy		t _{rr} przy		C _r przy		U _R	f _p				
	V	V	mA	mA	mW	°C	°C	°C	min	max	mA	nA	V	V	pF	V	MHz					
	max	max	max	max	max	max	max	max	max	max	max	max	max	max	max	max	max					
1	2	3	4	5	6	7	8	9	10	11	12	13	14	15	16	17	18	19	20	21		
BA 152 P		15	100			100	-40 ... +100	-40 ... +100		1,1	100	10	10			2,5	3		a	CE 37		
BA 157		/400/	400	2000 ^{1/}		150	-40 ... +100	-40 ... +100		1,3	1	5	400	500		2	400		b	CE 31		
BA 158		/600/	400	2000 ^{1/}		150	-40 ... +100	-40 ... +100		1,3	1	5	600	300		1,8	600		b	CE 31		
BA 159		/1000/	400	2000 ^{1/}		150	-40 ... +100	-40 ... +100		1,3	1	5	1000	500		1,6	1000		b	CE 31		
BA 182		35	100			100	-40 ... +100	-40 ... +100		1,2	100	100	20			1,5	3		a	CE 37		
BAE 795	50	75	80	200	150	175	-40 ... +125	-55 ... +175		1,0	50	100	50	2	6	2	0		c	CE 45		
BAE 795 R																						
BAE 895 4/	50	75	2x80	2x200	200	175	-40 ... +125	-55 ... +175		1,0	50	100	50	2	6	2	0		c	CE 45		
BAE 995 4/	50	75	2x80	2x200	200	175	-40 ... +125	-55 ... +175		1,0	50	100	50	2	6	2	0		c	CE 45		
BAP 794	25	35	200	450	200	125	-40 ... +100	-40 ... +100		1,0	30	100	25	2 ^{2/}	6	4	0	1	d	CE 37		
BAP 794 A	30	40	200	450	200	125	-40 ... +100	-40 ... +100	0,62	0,7	2	50	30	2 ^{2/}	6	2	0	1	d	CE 37		
BAP 795	50	75	200	450	200	125	-40 ... +100	-40 ... +100		1,0	50	50	50	2 ^{2/}	6	2	0	1	d	CE 37		
BAP 795 A	50	75	200	450	200	125	-40 ... +100	-40 ... +100	0,7	0,81	10	50	50	2 ^{2/}	6	2	0	1	d	CE 37		
BAR 99	70	70	80	/200/	150	150	-40 ... +125	-55 ... +150		0,855	10	100	50	6	1	2	0	1	e	CE 46		
BAR 99 R																						
BAV 704/x	70	70	80	/200/	200	150	-40 ... +125	-55 ... +150		0,855	10	100	50	6	1	2	0	1	e	CE 46		
BAPV 10	50	60	300	/600/	500	200	-55 ... +125	-65 ... +175	0,82	0,92	100	100	50	4		2,5	0	1	f	CE 02		
BAPV 17	20	25	200	250	400	175	-55 ... +125	-65 ... +175		1,0	100	100	100	50 ^{3/}	10	5	0	1	e	CE 02		
BAPV 18	50	60	200	250	400	175	-55 ... +125	-65 ... +175		1,0	100	100	100	50 ^{3/}	10	5	0	1	e	CE 02		
BAPV 19	100	120	200	250	400	175	-55 ... +125	-65 ... +175		1,0	100	100	100	50 ^{3/}	10	5	0	1	e	CE 02		
BAPV 20	150	180	200	250	400	175	-55 ... +125	-65 ... +175		1,0	100	100	100	50 ^{3/}	10	5	0	1	e	CE 02		
BAPV 21	200	250	200	250	400	175	-55 ... +125	-65 ... +175		1,0	100	100	100	50 ^{3/}	10	5	0	1	e	CE 02		
BAW 564/x	70	70	80	/200/	200	150	-40 ... +125	-55 ... +150		0,855	10	100	50	6	1	2	0	1	e	CE 46		
BAPV 61	75	100	100	225	500	200	-55 ... +125	-65 ... +200		1,0	10	25	20	4	6	4	0	1	d	CE 02		

1	2	3	4	5	6	7	8	9	10	11	12	13	14	15	16	17	18	19	20	21
BAYP 94	25	35	200	450	500	200	-55 ... +125	-65 ... +200		1,0	30	100	25	2	6	2	0	1	d	CE 02
BAYP 94 A	30	40	200	450	500	200	-55 ... +125	-65 ... +200		0,7	2	50	30	2	6	4	0	1	d	CE 02
BAYP 95	50	75	200	450	500	200	-55 ... +125	-65 ... +200		1,0	50	50	50	2	6	2	0	1	d	CE 02
BAYP 95 A	50	75	200	450	500	200	-55 ... +125	-65 ... +200		0,81	10	50	50	2	6	2	0	1	d	CE 02

- a układy przełączające /głowice UHF/
 - b układy prostownicze
 - c układy hybrydowe
 - d szybkie układy przełączające
 - e układy przełączające i prostownicze małej mocy
 - f układy przełączające wysokiej jakości
- 1/ przy $f_p = 50 \text{ Hz}$; $t = 10 \text{ ms}$
- 2/ przy $I_p = 10 \text{ mA}$; $R_L = 100\Omega$; $i_{rr} = 1 \text{ mA}$
- 3/ przy $I_p = 30 \text{ mA}$; $I_R = 30 \text{ mA}$; $R_L = 100\Omega$; $i_{rr} = 3 \text{ mA}$
- 4/ duodioda
- x nowe uruchomienia

1.4. Diody przełączające specjalne

BA spec

Oznaczenie wyrobu	Parametry graniczne / $t_{amb} = 25^{\circ}C$ /				Parametry charakterystyczne / $t_{amb} = 25^{\circ}C$ /						Zastosowanie	Obudowa
	U_R / U_{RRM} /	I_F / I_{FM} /	P_{tot}	t_j	U_F przy	I_F przy	I_R przy	U_R	t_{rr}	C_T		
	V max	mA max	mW max	$^{\circ}C$ max	V max	mA max	mA max	V	ns max	pF /typ/ max		
1	2	3	4	5	6	7	8	9	10	11	12	13
BAAP 57 ¹ /	/400/	400		150	1,3	1	5000	400	500	/2/	a	CE 31
BAAF 58 ¹ /	/600/	400		150	1,3	1	5000	600	500	/1,8/	a	CE 31
BAAP 59 ¹ /	/1000/	400		150	1,3	1	5000	1000	500	/1,6/	a	CE 31
BABE 95	50	2x80 /2x200/	200	175	1	50	100	50	2	2	b	CE 45
BACE 95	50	80/200/	150	175	1	50	100	50	2	2	b	CE 45
BACE 95 R	50	80/200/	150	175	1	50	100	50	2	2	b	CE 45
BACP 61	75	100	500	200	1	10	25	20	4	4	c	CE 02
BACP 95	50	200 /450/	500	200	1	50	50	50	2	2	c	CE 02
BABE 95	50	2x80 /2x200/	200	175	1	50	100	50	2	2	b	CE 45
BAFP 10	50	300	500	200	0,92	100	100	50	4	2,5	e	CE 02
BAFP 19	100	/250/	400	175	1	100	100	100	502/	5	d	CE 02
BAFP 20	150	/250/	400	175	1	100	100	150	502/	5	d	CE 02
BAFP 21	200	/250/	400	175	1	100	100	200	502/	5	d	CE 02

a szybkie układy prostownicze

b układy hybrydowe

c szybkie przełączniki, modulatory, dekodery

d przełączniki

e układy przełączające wysokiej jakości

1/ $I_{RRM} \leq 2$ A przy $f = 50$ Hz, $t = 10$ ms t_{rr} przy $I_F = I_R = 10$ mA, $i_{rr} = 1$ mA2/ t_{rr} przy $I_F = I_R = 30$ mA, $R_L = 100\Omega$, $i_{rr} = 3$ mA

1.5. Diody stabilizacyjne

BA

Oznaczenie wyrobu	Parametry graniczne / $t_{amb} = 25^{\circ}C/$			Parametry charakterystyczne / $t_{amb} = 25^{\circ}C/$						Zastosowanie	Obudowa
	I_F	U_{RM}	t_j	$I_F = 5 \text{ mA}$			I_R przy				
				U_F	r_F	α_{UF}	U_R				
	mA	V	$^{\circ}C$	V	Ω	$10^{-4}/^{\circ}C$	μA	V			
	max	max	max	min	max	max	max	max			
1	2	3	4	5	6	7	8	9	10	11	
BAP 811	50	6	150	1,45	20	-20	1	6		CE 35	
BAP 812	50	6	150	2,0	30	-25	1	6	układy starbilizacji i ograniczenia napięcia	CE 35	

1.6. Stabilistory (diody Zenera)

BZ

Oznaczenie wyrobu	Parametry graniczne /t _{amb} = 25°C/					Parametry charakterystyczne /t _{amb} = 25°C/										Zasto- sowa- nie	Obu- dowa
	I _F	P _{tot}	t _j	t _{amb}	t _{stg}	I _R przy	U _R	U _F przy		I _F	U _Z	r _Z	α _{UZ} przy				
								μA	V				V	A	10 ⁻⁴ /°C		
	max	max	max	°C	°C	max	max	max	min	nom	max	max	max	max			
1	2	3	4	5	6	7	8	9	10	11	12	13	14	15	16	17	18
BZP 630 - - C7V5 - C8V5 - C9V1 - C10 - C11 - C12 - C13 - C15 - C16 - C18 - C20 - C22 - C24 - C27 - C30 - C33 - D8V2 - D10 - D12 - D15 - D18 - D22 - D27 - D30 - D33	0,2	0,25	150	-25 ... +85	-40 ... +125	1	1,5 3 3 4,5 4,5 6,5 6,5 11 11 12 14 15 16 18 20 22	1,2	0,1	7,0 7,7 8,5 9,4 10,4 11,4 12,4 13,8 15,3 16,8 18,8 20,8 22,8 25,1 28 31	7,5 8,2 9,1 10 11 12 13 15 16 18 20 22 24 27 30 33	7,9 8,7 9,6 10,6 11,6 12,7 14,1 15,6 17,1 19,1 21,2 23,3 25,6 28,9 32 35	10 10 15 15 20 30 30 35 40 55 55 58 80 80 90 90	+5,0 +5,5 +6,0 +6,5 +7,0 +7,0 +7,5 +7,5 +8,0 +8,0 +8,0 +8,5 +8,5 +9,0 +9,0	5	układy stabilizacji i ograniczenia napięcia	CE 12

1	2	3	4	5	6	7	8	9	10	11	12	13	14	15	16	17	18
BZP 650 -	3	1,2	150	-25 ... +85	-40 ... +100	0,5	3	1,2	0,5	6,4	6,8	7,2	2	/+7/	100	układy	CE 39
- C6V8							5			7,0	7,5	7,9	2	/+7/	100	stabil-	
- C7V5							6			7,7	8,2	8,7	2	/+8/	100	lizacji	
- C8V2							7			8,5	9,1	9,6	4	/+8/	100	i ogra-	
- C9V1							7,5			9,4	10	10,6	4	/+9/	50	nia na-	
- C10							8,5			10,4	11	11,6	7	/+10/	50	pięcia	
- C11							9			11,4	12	12,7	7	/+10/	50		
- C12							10			12,4	13	14,1	9	/+10/	50		
- C13							11			13,8	15	15,3	9	/+11/	50		
- C15							12			15,3	16	17,1	10	/+11/	25		
- C16							14			16,8	18	19,1	11	/+11/	25		
- C18							15			18,8	20	21,2	12	/+11/	25		
- C20							17			20,8	22	23,3	13	/+11/	25		
- C22							18			22,8	24	25,6	14	/+11/	25		
- C24							20			25,1	27	28,9	15	/+11/	25		
- C27							22,5			28	30	32	20	/+11/	25		
- C30							25			31	33	35	20	/+11/	25		
- C33													20				
- D6V8							3			6,0	6,8	7,5	2	/+7/	100		
- D8V2							6			7,3	8,2	9,2	4	/+7/	100		
- D10							7,5			8,8	10	11	4	/+9/	50		
- D12							9			10,7	12	13,4	7	/+10/	50		
- D15							11			13	15	16,5	9	/+10/	50		
- D18							14			16	18	20	11	/+11/	25		
- D22							17			19,6	22	24,4	13	/+11/	25		
- D27							20			24,1	27	30	15	/+11/	25		
- D33							25			29,6	33	36,5	20	/+11/	25		
BZP 683 -	0,2	0,4	150	-40 ... +125	-55 ... +150		1	1,1	0,1	3,1	3,3	3,5	100	-6	5	układy	CE 02
- C3V3						30	1			3,4	3,6	3,8	100	-6		stabil-	
- C3V6						20	1			3,7	3,9	4,1	100	-5,5		lizacji	
- C3V9						10	1			4,0	4,3	4,6	100	-4,5		i ogra-	
- C4V3						5	1			4,4	4,7	5,0	90	-2,5		nia na-	
- C4V7						2	1			4,8	5,1	5,4	75	+2,0		pięcia	
- C5V1						1	1			5,2	5,6	6,0	60	+3,0			
- C5V6						1	1										

1	2	3	4	5	6	7	8	9	10	11	12	13	14	15	16	17	18
BZYP 01C150 ^x							75			138	150	156	300			stabilizacja i ograniczenie napięcia w układach motoryzacyjnych	
BZYP 01C160 ^x	0,2	1,3	175	-40 ... +150	-40 ... +175	1	75	1,5	0,2	153	160	171	350				
BZYP 01C180 ^x							90			168	180	191	350				
BZYP 01C200 ^x							90			188	200	212	350				

1/ stabilizatory obrotów silnika magnetofonów bateryjnych

2/ napięcie w kierunku przewodzenia przy $I_p = 5 \text{ mA}$

^x nowe uruchomienia

1.7. Stabilizatory (diody Zenera) specjalne

BZ spec

Oznaczenie wyrobu	P _{tot} W max	Parametry charakterystyczne / t _{amb} = 25°C /										Zastosowanie	Obudowa
		I _R przy		U _R V	U _Z			I _Z Ω max	α _{UZ} przy 10 ⁻⁴ /°C typ	I _Z mA			
		μA max	V max		I _P A	min	nom				max		
		3	4	5	6	7	8	9	10	11			
1	2	3	4	5	6	7	8	9	10	11	12		
BZAP 30 - - C7V5 - C8V2 - C9V1 - C10 - C11 - C12 - C13 - C15 - C16 - C18 - C20 - C22 - C24 - C27 - C30 - C33	0,25 ^{1/}	1	1,5 3 3 4,5 4,5 6,5 6,5 11 11 12 14 15 16 18 20 22	1,2	0,1	7,0 7,7 8,5 9,4 10,4 11,4 12,4 13,8 15,3 16,8 18,3 20,8 22,8 25,1 28 31	7,5 8,2 9,1 10,6 11,6 12,7 14,1 15,6 17,1 19,4 21,1 23,3 25,6 28,9 32 35	10 10 15 15 20 30 30 35 40 55 55 58 80 80 90 90	+5,0 +5,5 +6,0 +6,5 +7,0 +7,5 +7,5 +8,0 +8,0 +8,5 +8,5 +8,5 +9,0 +9,0	5	Stabilizacja i ograniczanie napięcia	CE 12	
BZAP 83 - - C3V3 - C3V6 - C3V9 - C4V3 - C4V7 - C5V1 - C5V6	0,4 ^{1/}	30 20 10 5 2 1 1	1 1 1 1 1 1 1	1,1	0,1	3,1 3,4 3,7 4,0 4,4 4,8 5,3	3,3 3,6 3,9 4,3 4,7 5,1 5,6	3,5 3,8 4,1 4,6 5,0 5,4 6,0	100 100 100 100 90 75 60	-6,0 -6,0 -5,5 -4,5 -2,5 +2,0 +3,0	5	Stabilizacja i ograniczanie napięcia	CE 02

1	2	3	4	5	6	7	8	9	10	11	12	
- C6V2		1	1			5,8	6,2	6,6	40	+4,0		
- C6V8		1	1,5			6,4	6,8	7,2	15	+4,5		
- C7V5		1	1,5			7,0	7,5	7,9	10	+5,0		
- C8V2		1	3			7,7	8,2	8,7	10	+5,5		
- C9V1		1	3			8,5	9,1	9,6	15	+6,0		
- C10		1	4,5			9,4	10	10,6	15	+6,5		
- C11		1	4,5			10,4	11	11,6	20	+7,0		
- C12		1	6,5			11,4	12	12,8	20	+7,0		
- C13		1	6,5			12,4	13	14,1	25	+7,5		
- C15		1	11			13,8	15	15,6	30	+7,5		
- C16		1	11			15,3	16	17,1	40	+8,0		
- C18		1	12			16,8	18	19,1	55	+8,0		
- C20		1	14			18,8	20	21,2	55	+8,0		
- C22		1	15			20,8	22	23,3	58	+8,5		
- C24		1	15			22,8	24	25,6	80	+8,5		
- C27		1	18			25,1	27	28,9	80	+8,5		
- C30		1	20			28	30	32	90	+9,0		
- C33		1	22			31	33	35	90	+9,0		

$$1/ I_{Pmax} = 0,2 A; I_{Zmax} = \frac{P_{tot}}{U_Z}; t_{jmax} = 150^{\circ}C$$

1.8. Diody pojemnościowe (warikapły)

Oznaczenie wyrobu	Parametry graniczne / $t_{amb} = 25^{\circ}C$ /				Parametry charakterystyczne / $t_{amb} = 25^{\circ}C$ /										Zastosowanie	Obudowa
	U_R	U_{RM}	I_F	C_r przy $f_p = 1$ MHz	C_r/U_{R1} / U_r/U_{R2} przy		r_s	Q	r_s lub Q przy		Zastosowanie	Obudowa				
					U_{R1}	U_{R2}			f_p	C_r						
	V	V	mA	pF	V	V	Ω	min/typ/	MHz	pF						
max	max	max	min	max	min	max	max	max	max	max	max	max				
1	2	3	4	5	6	7	8	9	10	11	12	13	14	15		
BB 104 ^{1/}	30		100	34	42	3	2,5	2,8	3	30	0,4	135	100	38	a	CE 34
BB 104 B ^{1/}	30		100	37	42	3	2,5	2,8	3	30	0,4	135	100	38	a	CE 34
BB 104 G ^{1/}	30		100	34	39	3	2,5	2,8	3	30	0,4	135	100	38	a	CE 34
BB 105 A ^{3/}	28	30		2,3	2,8	25	4	5	3	25	0,8		470	9	b	CE 37
BB 105 AD ^{3/}	28	30		2,2	2,8	25	4,5	6	3	25	0,8		470	9	b	CE 37
BB 105 B ^{3/}	28	30		2,0	2,3	25	4,5	6	3	25	0,8		470	9	b	CE 37
BB 105 G ^{3/}	28	30		1,8	2,8	25	4	6	3	25	1,2		470	9	b	CE 37
BB 105 GD ^{3/}	28	30		1,8	2,8	25	4,5	6	3	25	1,2		470	9	b	CE 37
BB 109 3/x	28	30		4,3	6,0	25	4,3	6	3	25		/280/	50	3	b	CE 37

a przestrajanie obwodów VHF

b przestrajanie obwodów VHF, UHF

x nowe uruchomienia

1/ powojna dioda ze wspólną katodą

2/ $t_{jmax} = 100^{\circ}C$

3/ mogą być dobrane w komplety po 2, 3, 4 1 6

1.9. Diody pojemnościowe (warikapły) specjalne

BBspec

Oznaczenie wyrobu	Parametry graniczne / $t_{amb} = 25^{\circ}C$ /										Parametry charakterystyczne / $t_{amb} = 25^{\circ}C$ /										Zastosowanie	Obudowa
	U_R		U_{RM}		t_j		C_T		przy		$\frac{C_T/U_{R1}}{C_T/U_{R2}}$		przy		r_s		f_p		C_T			
	V	max	V	max	$^{\circ}C$	min	max	V	max	V	max	min	max	V	max	Ω	max	MHz	PF	PF		
	2	3	3	3	4	5	5	6	7	8	9	10	11	12	13	14	15	15	15	15		
BBAP 05 A	28	30	125	2,3	2,8	25	1	4	5	3	25	0,8	470	9	CE 37	stroje- nie obu- dów re- zonanso- wych w zakresie VHF i UHF	CE 37					
BBAP 05 B	28	30	125	2	2,3	25	1	4,5	6	3	25	0,8	470	9	CE 37		CE 37					
BBAP 05 G	28	30	125	1,8	2,8	25	1	4	6	3	25	1,2	470	9	CE 37		CE 37					

1.11. Tyristory specjalne

BT spec

Oznaczenie wyrobu	Parametry graniczne / $t_{amb} = 25^{\circ}C$; $f = 50$ Hz/										Parametry charakterystyczne / $t_{amb} = 25^{\circ}C$ /										Zasto- sowanie	Obudowa
	U_{DSM}	U_{DRM}	U_{RRM}	I_G	I_T / AV	I_T / RMS	I_{TSM} I_{TSM}	$\frac{dI_T}{dt}$	P_{GM}	U_F przy I_F	I_{GT}	U_{CT}	U_D	R_L	U_T przy I_T							
	V MAX	V MAX	V MAX	A MAX	A MAX	A MAX	A MAX	A/ μ S MAX	W MAX	V MAX	mA MAX	V MAX	V MAX	Ω MAX	V MAX							
1	2	3	4	5	6	7	8	9	10	11	12	13	14	15	16	17	18	19	20			
BTAP 28-400	450	400	4	31/	51/	81/	70	200 ² /	25	2	10	45	4	12	30	3	30	szybki tyrystor	CE 30			
BTAP 28-550	650	550	4	31/	51/	81/	70	200 ² /	25	2	10	45	4	12	30	3	30	xinte- growany z diodą	CE 30			
BTAP 29-650	700	650	4	31/	51/	81/	70	200 ² /	25	1,7	10	40	4	12	30	3	30		CE 30			
BTAP 29-750	800	750	4	31/	51/	81/	70	200 ² /	25	1,7	10	40	4	12	30	3	30		CE 30			

1/ $t_{case} = 60^{\circ}C$; $\theta = 180^{\circ}$; $f_p = 50$ Hz

2/ $U_D = U_{DRM}$; $I_G = 50$ mA; $t_r = 0,1$ μ s

1.12. Rysunki obudów

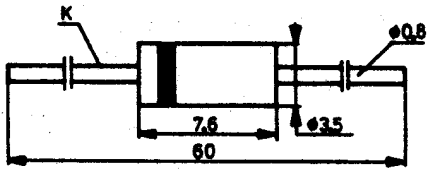

CE 01	DO 7	CB 26
-------	------	-------

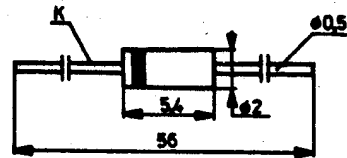

CE 02	DO 35	CB102
-------	-------	-------

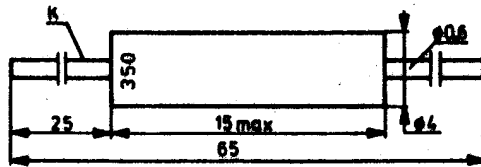

CE 08		
-------	--	--

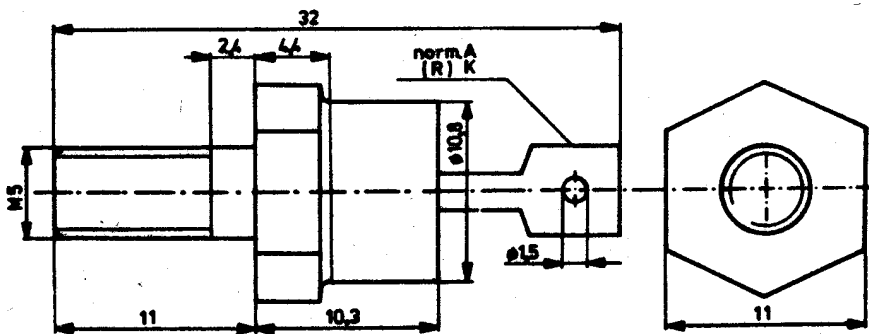

CE 11	DO 4	CB 33
-------	------	-------

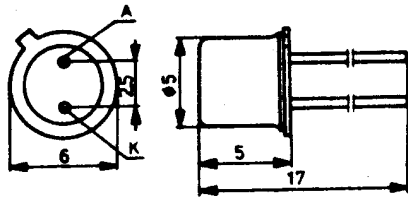

CE 12		CB 85
-------	--	-------

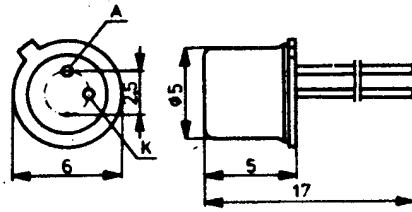

CE 22	TO 18	CB 6
-------	-------	------

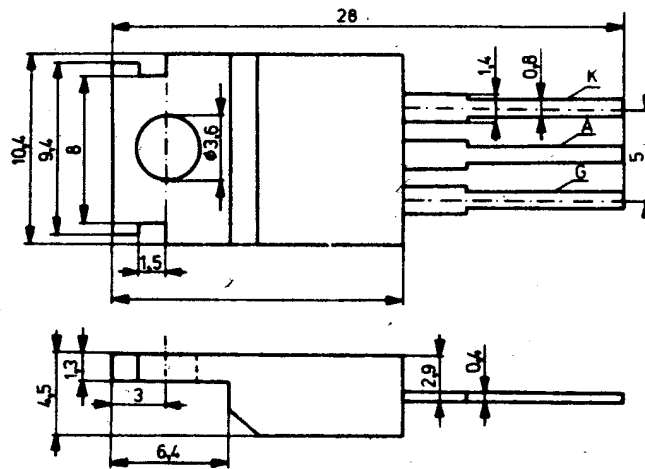

CE 30	TO 220	
-------	--------	--

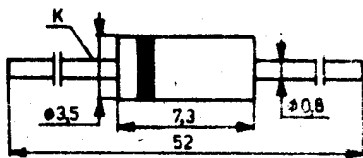

CE 31		
-------	--	--

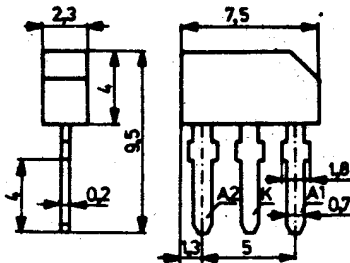

CE 34	SOT 33	CB 12
-------	--------	-------

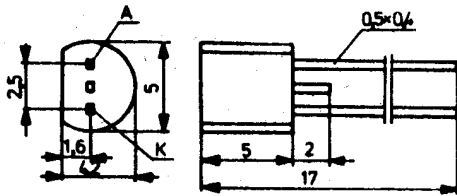

CE 35	TO 92	CB 97
-------	-------	-------

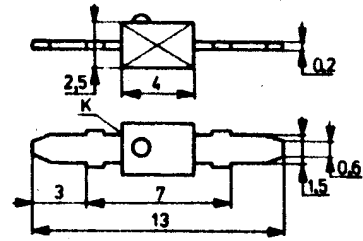

CE 37	SOD23	CB 14
-------	-------	-------

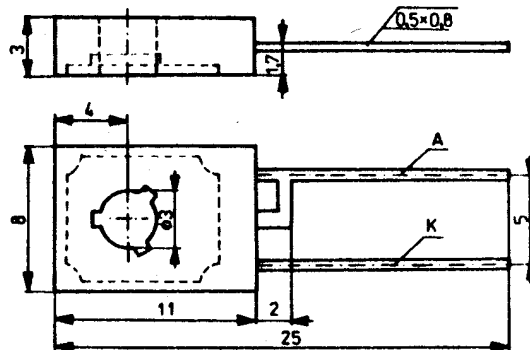

CE 39	SOT32
-------	-------

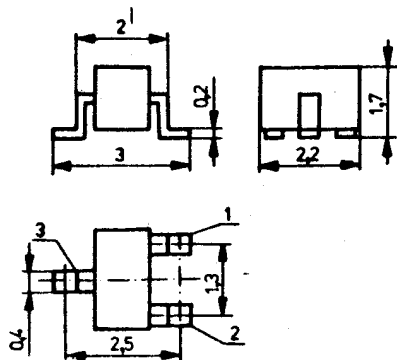

	1	2	3
BACE95, BAE795	A	-	K
BACE95R, BAE795R	-	A	K
BADE95, BAE995	K1	K2	A
BABE95, BAE895	A1	A2	K

CE 45			
-------	--	--	--

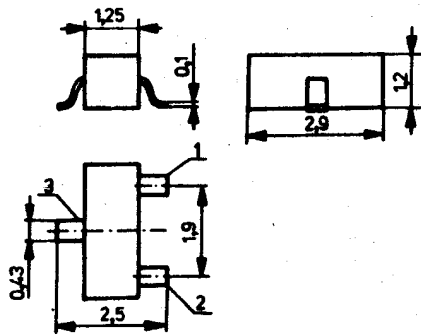

	1	2	3
BAV70	A1	A2	K
BAW56	K1	K2	A
BAR99	-	A	K
BAR99R	A	-	K

CE46		SOT23	
------	--	-------	--

This datasheet has been download from:

www.datasheetcatalog.com

Datasheets for electronics components.