

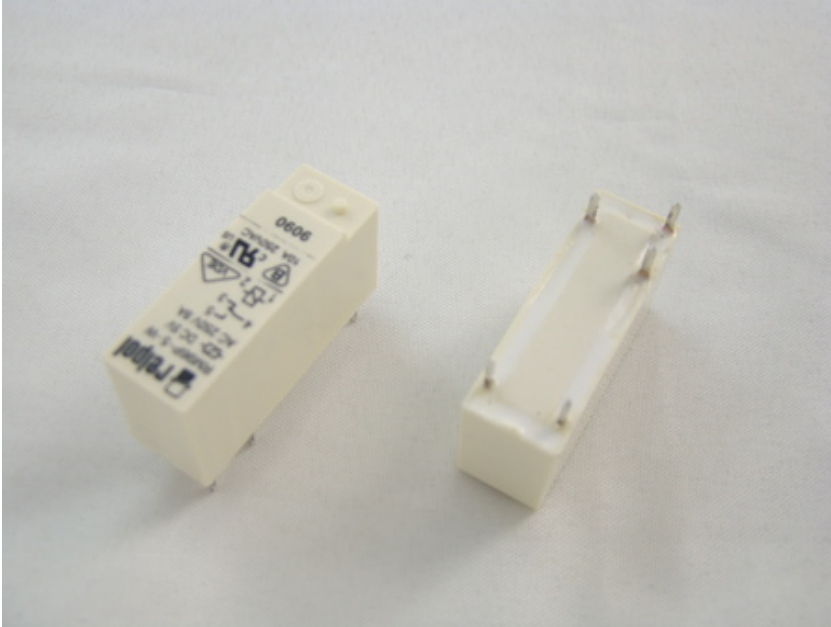

Przełącznik RM96-3011-35-1005 RELPOL

Ucewki:5VDC;8A/250VAC;1P;RoHS



Dane techniczne:

Nazwa: RM96-3011-35-1005

Konfiguracja styków: 1 styk przełączny





Napięcie cewki: 5VDC

Obciążalność styków: 8A

Producent: RELPOL

Certyfikat: RoHS



- Height 16,2 mm • IP 40 and IP 67
- For PCB (1 C/O, 1 NO, 1 NC) and plug-in sockets (1 C/O)
- Accessories: sockets and modules for 1 C/O
- DC coils
- Recyclable packing
- Terminals raster: 3,2 mm for version 1 C/O,
5,0 mm for version 1 NO and 1 NC
- Recognitions, certifications, directives: RoHS,    

Contact data

Number and type of contacts		1 C/O, 1 NO, 1 NC	
Contact material		AgSnO₂ , AgSnO ₂ /Au 3 μm, AgCdO	
Max. switching voltage	AC/DC	400 V / 250 V	
Min. switching voltage		10 V AgSnO ₂ , 5 V AgSnO ₂ /Au 3 μm, 10 V AgCdO	
Rated load	AC1	8 A / 250 V AC	
	DC1	8 A / 24 V DC	
Min. switching current		10 mA AgSnO ₂ , 2 mA AgSnO ₂ /Au 3 μm, 5 mA AgCdO	
Max. inrush current		15 A	
Rated current		8 A	
Max. breaking capacity	AC1	2 000 VA	
Min. breaking capacity		1 W AgSnO ₂ , 0,05 W AgSnO ₂ /Au 3 μm, 0,5 W AgCdO	
Contact resistance		≤ 100 mΩ	
Max. operating frequency	AC1	• at rated load	600 cycles/hour
		• no load	72 000 cycles/hour

Coil data

Rated voltage	DC	5...48 V
Must release voltage		DC: ≥ 0,1 U _n
Operating range of supply voltage		see Table 1
Rated power consumption	DC	0,22...0,3 W

Insulation

Insulation category		C250
Insulation rated voltage		400 V AC
Rated surge voltage		4 000 V AC
Overvoltage category		III PN-EN 60664-1
Insulation pollution degree		3
Dielectric strength	• between coil and contacts	4 000 V AC
	• contact clearance	1 000 V AC
Contact - coil distance	• clearance	≥ 8 mm
	• creepage	≥ 8 mm

General data

Operating time (typical value)		10 ms
Release time (typical value)		5 ms
Electrical life	• resistive AC1	> 10 ⁵ 8 A, 250 V AC
	• cos φ	see Fig. 3
Mechanical life (cycles)		> 2 x 10 ⁷
Motor load - according to the UL 508	1/4 HP	120 V AC, single-phase motor
	1/2 HP	250 V AC, single-phase motor
Dimensions (L x W x H)	1 C/O:	30 x 10 x 16,2 mm
	1 NO, 1 NC:	28 x 10 x 16,2 mm
Weight		11 g
Ambient temperature	• storage	-40...+85 °C
	• operating	-40...+80 °C
Cover protection category		IP 40 or IP 67
Environmental protection		RTII PN-EN 116000-3
Shock resistance		20 g
Vibration resistance		10 g 10...150 Hz
Solder bath temperature		max. 270 °C
Soldering time		max. 5 s

The data in bold type pertain to the standard versions of the relays.

Coil data - DC voltage version

Table 1

Coil code	Rated voltage V DC	Coil resistance ±10% at 20 °C Ω	Coil operating range at 20 °C V DC	
			min.	max.
1005	5	110	3,5	12,0
1006	6	160	4,2	14,5
1009	9	360	6,3	22,0
1012	12	660	8,4	29,5
1018	18	1 500	12,6	44,0
1024	24	2 200	16,8	54,0
1048	48	8 000	33,6	102,0

The data in bold type pertain to the standard versions of the relays.

Dimensions

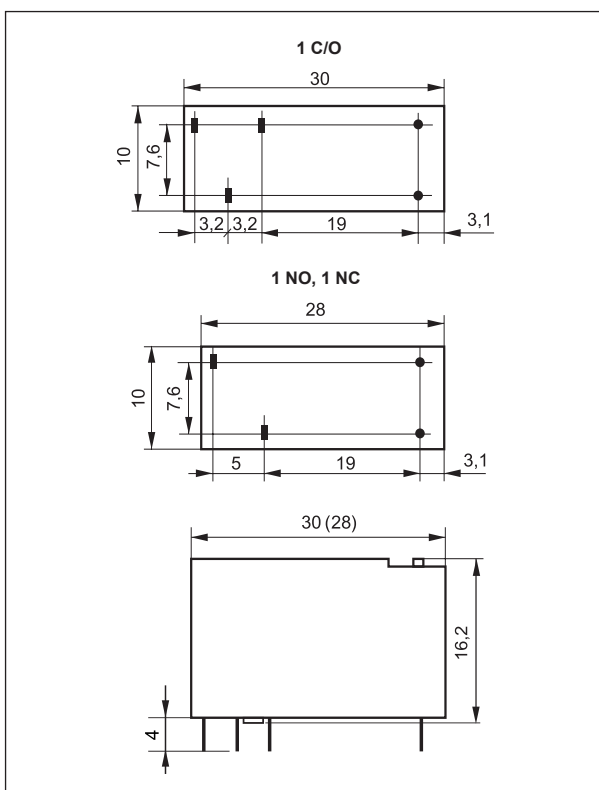

Connections diagrams (pin side view)

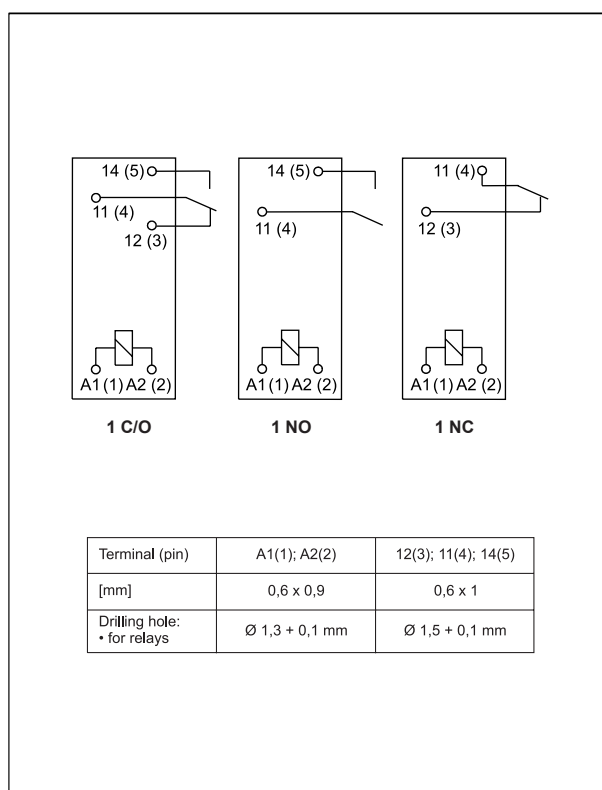

Mounting openings raster (solder side view)

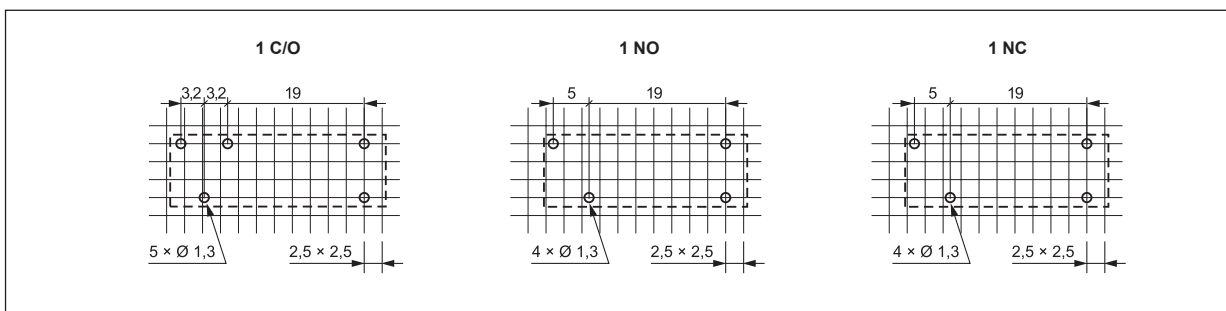

Max. breaking capacity
A - resistive load DC
B - resistive load AC

Fig. 1

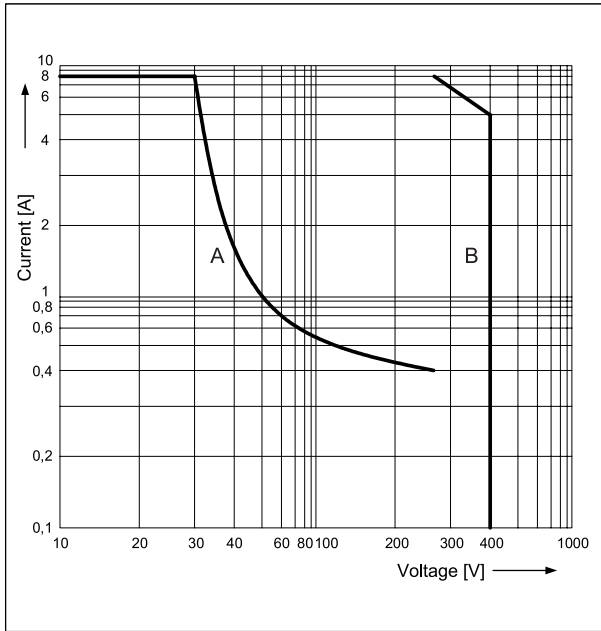

Electrical life at AC resistive load for version 1NO

Fig. 2

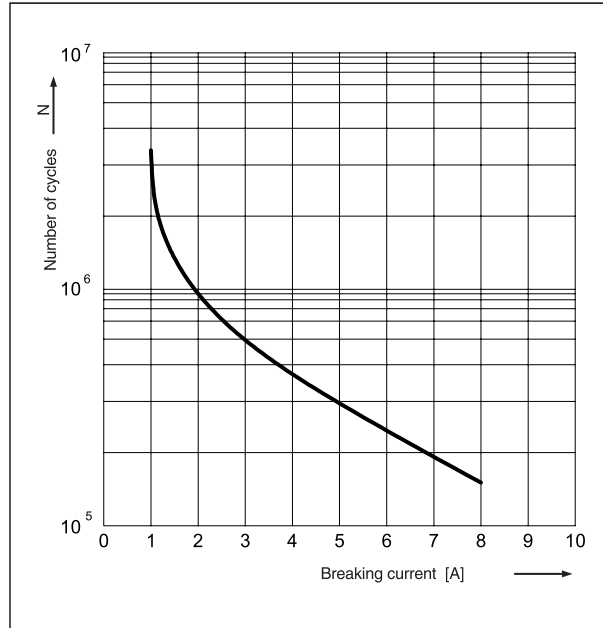

Electrical life reduction factor at AC inductive load

Fig. 3

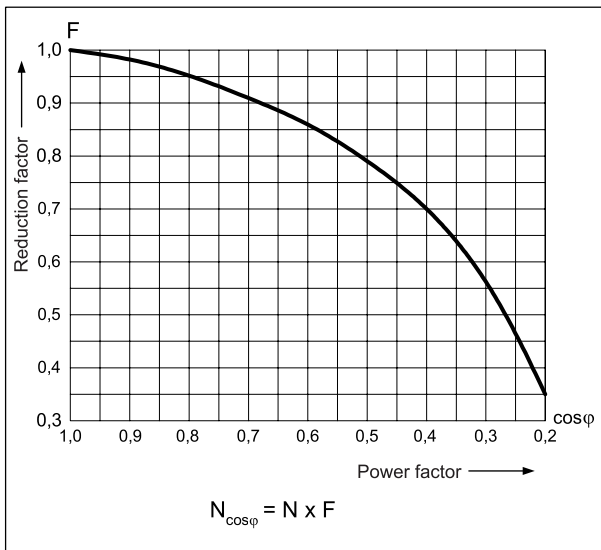

Coil operating range - DC

Fig. 4

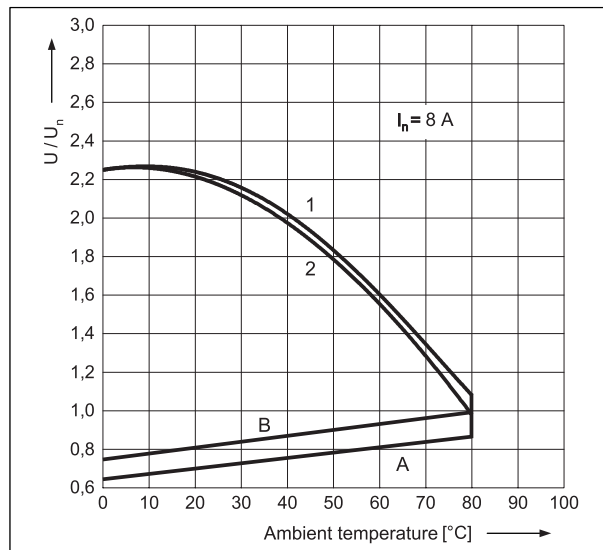

Description of Fig. 4

A - relations between make voltage and ambient temperature at no load on contacts. Coil temperature and ambient temperature are equal before coil energizing. Make voltage is not higher than the value read on Y axis (multiplication of rated voltage).

B - relations between make voltage and ambient temperature after initial coil heating up with 1,1 U_n, at continues load of I_n on contacts. Make voltage is not higher than the value read on Y axis (multiplication of rated voltage).

1, 2 - values on Y axis represent allowed overvoltage on coil at certain ambient temperature and contact load:

- 1 - no load
- 2 - rated load

Mounting

Relays **RM96 1 C/O** (one changeover contact) are designed for: • direct PCB mounting • screw terminals plug-in sockets **GZ96** with clip **MS16**, 35 mm DIN rail mount, EN 50022 or on panel mounting. Signalling / protecting modules **type M...** are available with sockets (see page 198).

Relays **RM96 1 NO** (one normally open contact) and **RM96 1 NC** (one normally closed contact) are designed for direct PCB mounting.

Ordering codes

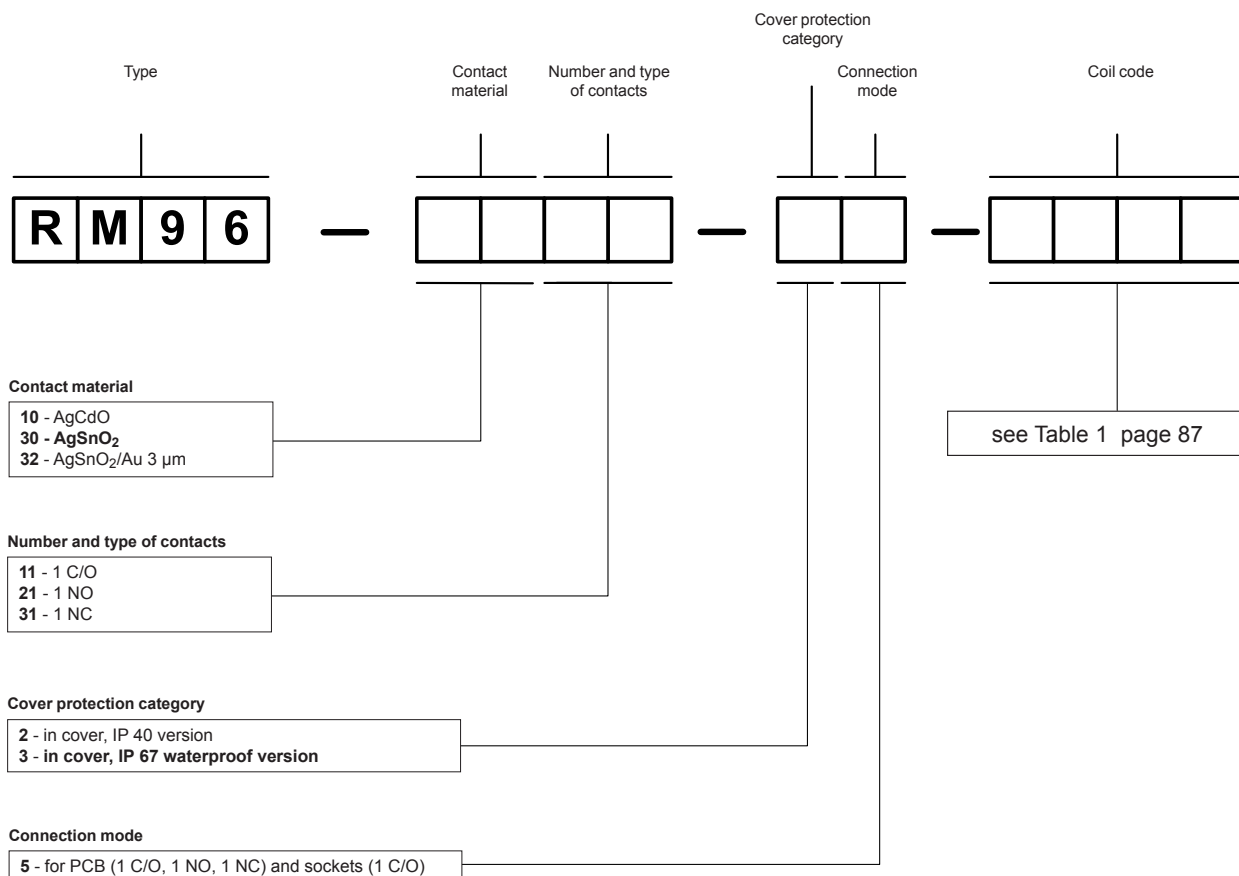

Examples of ordering codes:

- RM96-3011-35-1012** relay **RM96**, contact material AgSnO₂, with one changeover contact, in cover IP 67, for PCB and sockets, voltage version 12 V DC
- RM96-3031-25-1024** relay **RM96**, contact material AgSnO₂, with one normally closed contact, in cover IP 40, for PCB, voltage version 24 V DC

Print on relay cover

Type marking on relays cover **RM96** do not match the ordering codes.

Example of marking:

- RM96P-24-W** **RM96P** - relay **RM96**, with one changeover contact
24 - voltage version 24 V DC
W - in cover, IP 67 waterproof version