

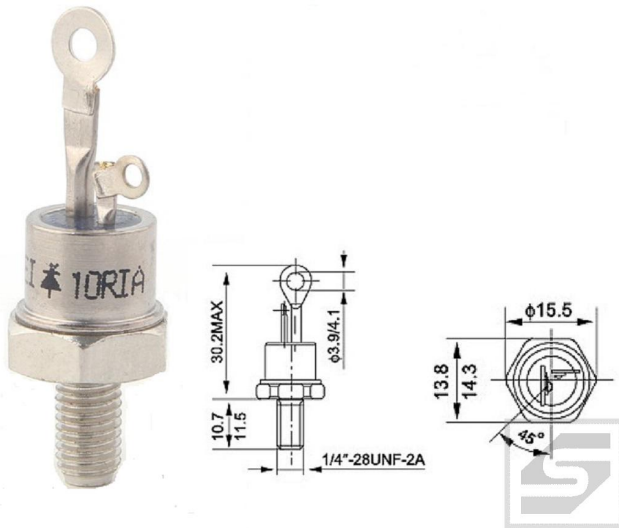

# Tyristor 10RIA120;Gregoo;TO48;M6; 10A;1200V;Prąd bramki 100mA;



## Dane techniczne:

Nazwa: 10RIA120

Typ: Tyristor

Napięcie wsteczne: 1200V

Prąd przewodzenia: 10A

Prąd bramki: 100mA

Obudowa: TO48

Producent: Gregoo

## Medium Power Thyristors (Stud Version), 10 A



TO-208AA (TO-48)

### FEATURES

- Improved glass passivation for high reliability and exceptional stability at high temperature
- High  $di/dt$  and  $dV/dt$  capabilities
- Standard package
- Low thermal resistance
- Metric threads version available
- Types up to 1200 V  $V_{DRM}/V_{RRM}$
- RoHS compliant
- Designed and qualified for industrial and consumer level



### PRODUCT SUMMARY

$I_{T(AV)}$	10 A
-------------	------

### TYPICAL APPLICATIONS

- Medium power switching
- Phase control applications
- Can be supplied to meet stringent military, aerospace and other high reliability requirements

### MAJOR RATINGS AND CHARACTERISTICS

PARAMETER	TEST CONDITIONS	VALUES	UNITS
$I_{T(AV)}$		10	A
	$T_C$	85	°C
$I_{T(RMS)}$		25	A
$I_{TSM}$	50 Hz	225	A
	60 Hz	240	
$I^2t$	50 Hz	255	A <sup>2</sup> s
	60 Hz	233	
$V_{DRM}/V_{RRM}$		100 to 1200	V
$t_q$	Typical	110	µs
$T_J$		- 65 to 125	°C

## ELECTRICAL SPECIFICATIONS

VOLTAGE RATINGS				
TYPE NUMBER	VOLTAGE CODE	$V_{DRM}/V_{RRM}$ , MAXIMUM REPETITIVE PEAK AND OFF-STATE VOLTAGE <sup>(1)</sup> V	$V_{RSM}$ , MAXIMUM NON-REPETITIVE PEAK VOLTAGE <sup>(2)</sup> V	$I_{DRM}/I_{RRM}$ MAXIMUM AT $T_J = T_J$ MAXIMUM mA
10RIA	10	100	150	10
	20	200	300	
	40	400	500	
	60	600	700	
	80	800	900	
	100	1000	1100	
	120	1200	1300	

### Notes

<sup>(1)</sup> Units may be broken over non-repetitively in the off-state direction without damage, if  $di/dt$  does not exceed 20 A/ $\mu$ s

<sup>(2)</sup> For voltage pulses with  $t_p \leq 5$  ms

ABSOLUTE MAXIMUM RATINGS					
PARAMETER	SYMBOL	TEST CONDITIONS		VALUES	UNITS
Maximum average on-state current at case temperature	$I_{T(AV)}$	180° conduction, half sine wave		10	A
				85	°C
Maximum RMS on-state current	$I_{T(RMS)}$			25	A
Maximum peak, one-cycle non-repetitive surge current	$I_{TSM}$	t = 10 ms	No voltage reapplied	Sinusoidal half wave, initial $T_J = T_J$ maximum	A
		t = 8.3 ms			
		t = 10 ms	100 % $V_{RRM}$ reapplied		
		t = 8.3 ms			
Maximum $I^2t$ for fusing	$I^2t$	t = 10 ms	No voltage reapplied		A <sup>2</sup> s
		t = 8.3 ms			
		t = 10 ms	100 % $V_{RRM}$ reapplied		
		t = 8.3 ms			
Maximum $I^2\sqrt{t}$ for fusing	$I^2\sqrt{t}$	t = 0.1 to 10 ms, no voltage reapplied		2550	A <sup>2</sup> $\sqrt{s}$
Low level value of threshold voltage	$V_{T(TO)1}$	$(16.7\% \times \pi \times I_{T(AV)} < I < \pi \times I_{T(AV)})$ , $T_J = T_J$ maximum		1.10	V
High level value of threshold voltage	$V_{T(TO)2}$	$(I > \pi \times I_{T(AV)})$ , $T_J = T_J$ maximum		1.39	
Low level value of on-state slope resistance	$r_{t1}$	$(16.7\% \times \pi \times I_{T(AV)} < I < \pi \times I_{T(AV)})$ , $T_J = T_J$ maximum		24.3	m $\Omega$
High level value of on-state slope resistance	$r_{t2}$	$(I > \pi \times I_{T(AV)})$ , $T_J = T_J$ maximum		16.7	
Maximum on-state voltage	$V_{TM}$	$I_{pk} = 32$ A, $T_J = 25$ °C, $t_p = 10$ ms sine pulse		1.75	V
Maximum holding current	$I_H$	$T_J = 25$ °C, anode supply 12 V resistive load		130	mA
Typical latching current	$I_L$			200	



## Medium Power Thyristors Vishay High Power Products (Stud Version), 10 A

SWITCHING				
PARAMETER	SYMBOL	TEST CONDITIONS	VALUES	UNITS
Maximum rate of rise of turned-on current	di/dt	T <sub>J</sub> = T <sub>J</sub> maximum, V <sub>DM</sub> = Rated V <sub>DRM</sub> Gate pulse = 20 V, 15 Ω, t <sub>p</sub> = 6 μs, t <sub>r</sub> = 0.1 μs maximum I <sub>TM</sub> = (2 x rated di/dt) A	200	A/μs
			180	
			160	
			150	
Typical turn-on time	t <sub>gt</sub>	T <sub>J</sub> = 25 °C, at rated V <sub>DRM</sub> /V <sub>RRM</sub> , T <sub>J</sub> = 125 °C	0.9	μs
Typical reverse recovery time	t <sub>rr</sub>	T <sub>J</sub> = T <sub>J</sub> maximum, I <sub>TM</sub> = I <sub>T(AV)</sub> , t <sub>p</sub> > 200 μs, di/dt = - 10 A/μs	4	
Typical turn-off time	t <sub>q</sub>	T <sub>J</sub> = T <sub>J</sub> maximum, I <sub>TM</sub> = I <sub>T(AV)</sub> , t <sub>p</sub> > 200 μs, V <sub>R</sub> = 100 V, di/dt = - 10 A/μs, dV/dt = 20 V/μs linear to 67 % V <sub>DRM</sub> , gate bias 0 V to 100 W	110	

**Note**

- t<sub>q</sub> = 10 μs up to 600 V, t<sub>q</sub> = 30 μs up to 1600 V available on special request

BLOCKING				
PARAMETER	SYMBOL	TEST CONDITIONS	VALUES	UNITS
Maximum critical rate of rise of off-state voltage	dV/dt	T <sub>J</sub> = T <sub>J</sub> maximum linear to 100 % rated V <sub>DRM</sub>	100	V/μs
		T <sub>J</sub> = T <sub>J</sub> maximum linear to 67 % rated V <sub>DRM</sub>	300 <sup>(1)</sup>	

**Note**

- <sup>(1)</sup> Available with: dV/dt = 1000 V/μs, to complete code add S90 i.e. 10RIA120S90

TRIGGERING					
PARAMETER	SYMBOL	TEST CONDITIONS	VALUES	UNITS	
Maximum peak gate power	P <sub>GM</sub>	T <sub>J</sub> = T <sub>J</sub> maximum	8.0	W	
Maximum average gate power	P <sub>G(AV)</sub>		2.0		
Maximum peak positive gate current	I <sub>GM</sub>	T <sub>J</sub> = T <sub>J</sub> maximum	1.5	A	
Maximum peak negative gate voltage	-V <sub>GM</sub>	T <sub>J</sub> = T <sub>J</sub> maximum	10	V	
DC gate current required to trigger	I <sub>GT</sub>	T <sub>J</sub> = - 65 °C	Maximum required gate trigger current/voltage are the lowest value which will trigger all units 6 V anode to cathode applied	mA	
		T <sub>J</sub> = 25 °C			90
		T <sub>J</sub> = 125 °C			60
DC gate voltage required to trigger	V <sub>GT</sub>	T <sub>J</sub> = - 65 °C		V	
		T <sub>J</sub> = 25 °C			3.0
		T <sub>J</sub> = 125 °C			2.0
DC gate current not to trigger	I <sub>GD</sub>	T <sub>J</sub> = T <sub>J</sub> maximum, V <sub>DRM</sub> = Rated value	1.0		
DC gate voltage not to trigger	V <sub>GD</sub>	T <sub>J</sub> = T <sub>J</sub> maximum, V <sub>DRM</sub> = Rated value	2.0	mA	
DC gate voltage not to trigger	V <sub>GD</sub>	T <sub>J</sub> = T <sub>J</sub> maximum, V <sub>DRM</sub> = Rated value	0.2	V	

THERMAL AND MECHANICAL SPECIFICATIONS					
PARAMETER	SYMBOL	TEST CONDITIONS	VALUES	UNITS	
Maximum operating junction and storage temperature range	$T_J, T_{Stg}$		- 65 to 125	°C	
Maximum thermal resistance, junction to case	$R_{thJC}$	DC operation	1.85	K/W	
Maximum thermal resistance, case to heatsink	$R_{thCS}$	Mounting surface, smooth, flat and greased	0.35		
			<b>TO NUT</b>	<b>TO DEVICE</b>	
Mounting torque		Lubricated threads (Non-lubricated threads)	20 (27.5)	25	lbf · in
			0.23 (0.32)	0.29	kgf · m
			2.3 (3.1)	2.8	N · m
Approximate weight			14		g
			0.49		oz.
Case style		See dimensions - link at the end of datasheet	TO-208AA (TO-48)		

$\Delta R_{thJC}$ CONDUCTION				
CONDUCTION ANGLE	SINUSOIDAL CONDUCTION	RECTANGULAR CONDUCTION	TEST CONDITIONS	UNITS
180°	0.44	0.32	$T_J = T_J$ maximum	K/W
120°	0.53	0.56		
90°	0.68	0.75		
60°	1.01	1.05		
30°	1.71	1.73		

**Note**

- The table above shows the increment of thermal resistance  $R_{thJC}$  when devices operate at different conduction angles than DC

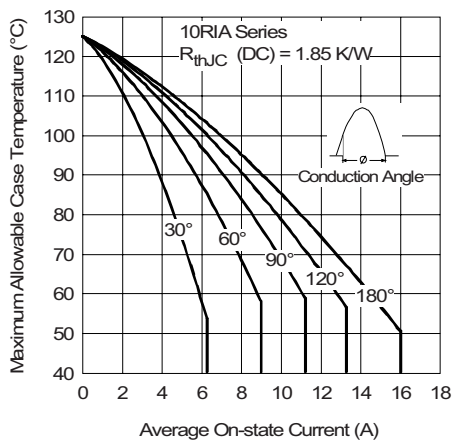

Fig. 1 - Current Ratings Characteristics

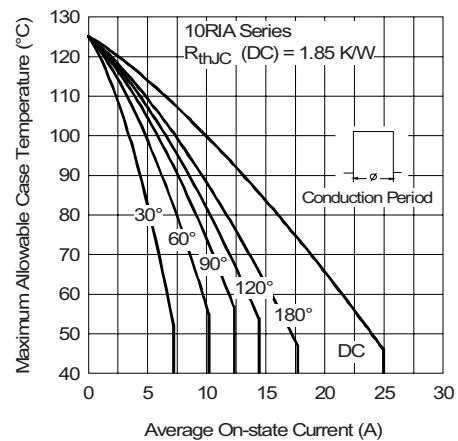

Fig. 2 - Current Ratings Characteristics



Medium Power Thyristors Vishay High Power Products  
(Stud Version), 10 A

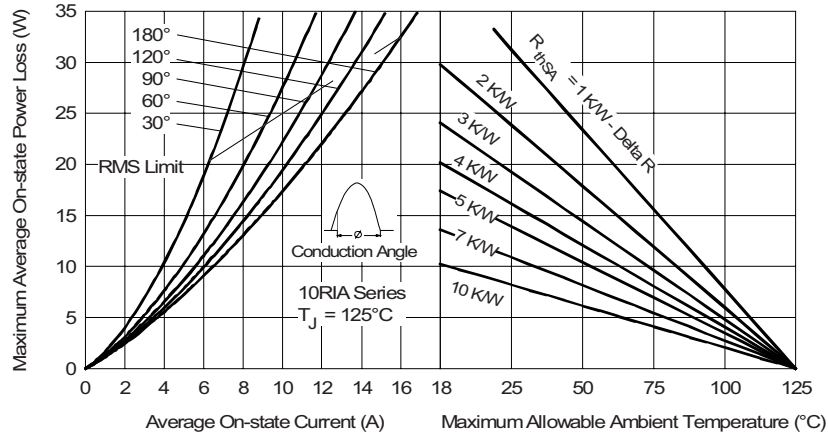

Fig. 3 - On-State Power Loss Characteristics

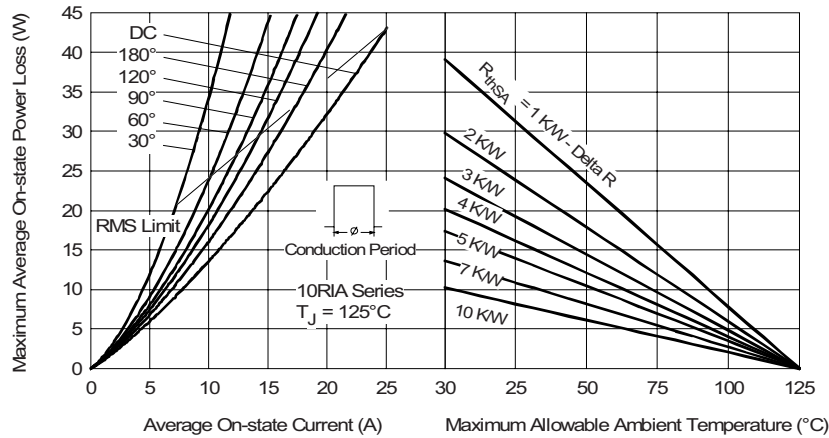

Fig. 4 - On-State Power Loss Characteristics

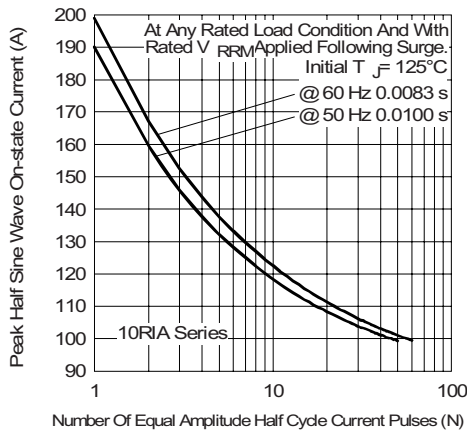

Fig. 5 - Maximum Non-Repetitive Surge Current

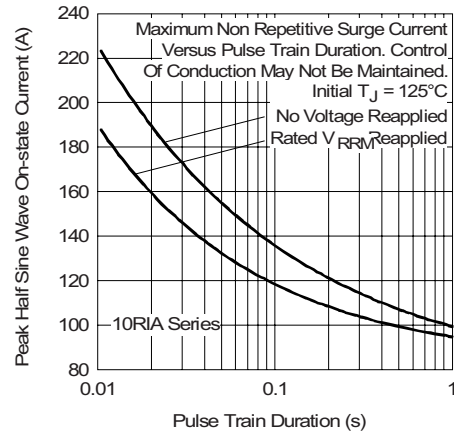

Fig. 6 - Maximum Non-Repetitive Surge Current

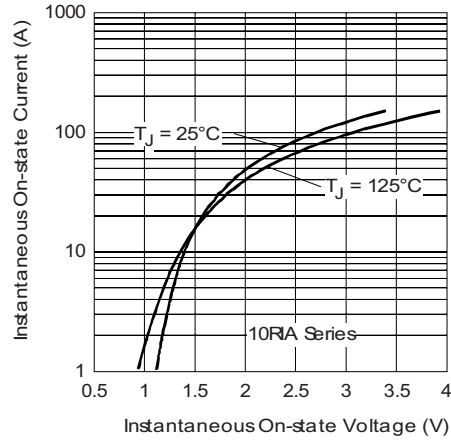

Fig. 7 - Forward Voltage Drop Characteristics

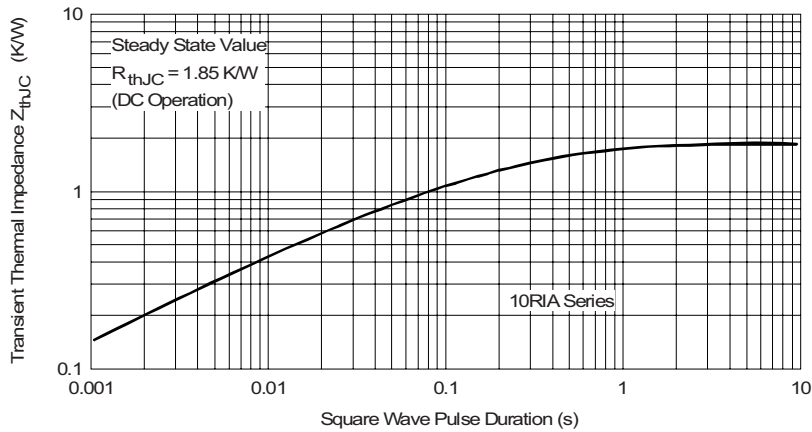

Fig. 8 - Thermal Impedance  $Z_{thJC}$  Characteristics

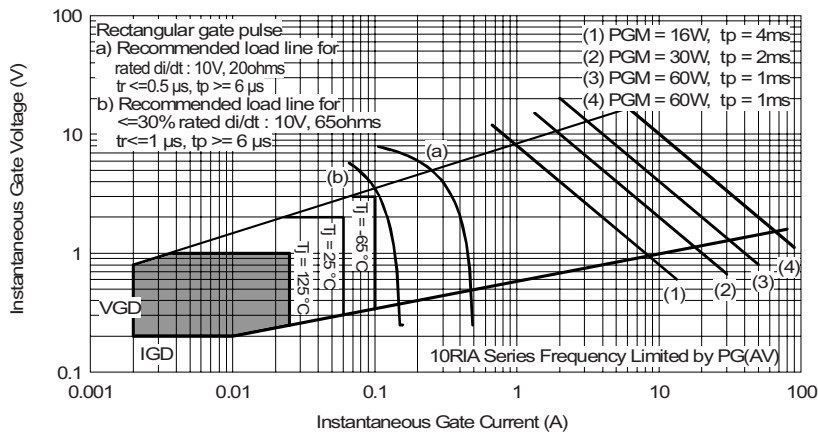
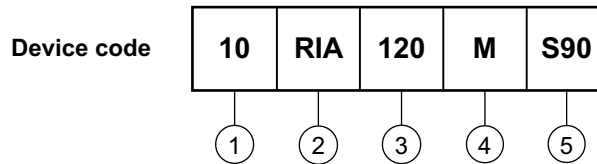

Fig. 9 - Gate Characteristics



### ORDERING INFORMATION TABLE



- 1** - Current code
- 2** - Essential part number
- 3** - Voltage code x 10 =  $V_{RRM}$  (see Voltage Ratings table)
- 4** - None = Stud base TO-208AA (TO-48) 1/4" 28UNF-2A  
M = Stud base TO-208AA (TO-48) M6 x 1
- 5** - Critical dV/dt:  
None = 300 V/ $\mu$ s (standard value)  
S90 = 1000 V/ $\mu$ s (special selection)

LINKS TO RELATED DOCUMENTS	
Dimensions	<a href="http://www.vishay.com/doc?95333">http://www.vishay.com/doc?95333</a>





## Disclaimer

All product specifications and data are subject to change without notice.

Vishay Intertechnology, Inc., its affiliates, agents, and employees, and all persons acting on its or their behalf (collectively, "Vishay"), disclaim any and all liability for any errors, inaccuracies or incompleteness contained herein or in any other disclosure relating to any product.

Vishay disclaims any and all liability arising out of the use or application of any product described herein or of any information provided herein to the maximum extent permitted by law. The product specifications do not expand or otherwise modify Vishay's terms and conditions of purchase, including but not limited to the warranty expressed therein, which apply to these products.

No license, express or implied, by estoppel or otherwise, to any intellectual property rights is granted by this document or by any conduct of Vishay.

The products shown herein are not designed for use in medical, life-saving, or life-sustaining applications unless otherwise expressly indicated. Customers using or selling Vishay products not expressly indicated for use in such applications do so entirely at their own risk and agree to fully indemnify Vishay for any damages arising or resulting from such use or sale. Please contact authorized Vishay personnel to obtain written terms and conditions regarding products designed for such applications.

Product names and markings noted herein may be trademarks of their respective owners.