

**APT2X101S20J 200V 120A**

## DUAL DIE ISOTOP® PACKAGE

### HIGH VOLTAGE SCHOTTKY DIODE

#### PRODUCT APPLICATIONS

- Rectifiers in Switchmode Power Supplies (SMPS)
- Free Wheeling Diode in Low Voltage Converters

#### PRODUCT FEATURES

- Ultrafast Recovery Times
- Soft Recovery Characteristics
- Popular SOT-227 Package
- Rugged - Avalanche Energy Rated
- Low Forward Voltage
- High Blocking Voltage
- Low Leakage Current

#### PRODUCT BENEFITS

- Low Losses
- Low Noise Switching
- Cooler Operation
- Higher Reliability Systems
- Increased System Power Density

#### MAXIMUM RATINGS

All Ratings:  $T_C = 25^\circ\text{C}$  unless otherwise specified.

Symbol	Characteristic / Test Conditions	APT2X101S20J	UNIT
$V_R$	Maximum D.C. Reverse Voltage	200	Volts
$V_{RRM}$	Maximum Peak Repetitive Reverse Voltage		
$V_{RWM}$	Maximum Working Peak Reverse Voltage		
$I_{F(AV)}$	Maximum Average Forward Current ( $T_C = 105^\circ\text{C}$ , Duty Cycle = 0.5)	120	Amps
$I_{F(RMS)}$	RMS Forward Current (Square wave, 50% duty)	213	
$I_{FSM}$	Non-Repetitive Forward Surge Current ( $T_J = 45^\circ\text{C}$ , 8.3ms)	1000	
$T_J, T_{STG}$	Operating and Storage Temperature Range	-55 to 150	$^\circ\text{C}$
$E_{AVL}$	Avalanche Energy (2A, 50mH)	100	mJ

#### STATIC ELECTRICAL CHARACTERISTICS

Symbol		MIN	TYP	MAX	UNIT
$V_F$	Forward Voltage	$I_F = 100\text{A}$	.89	.95	Volts
		$I_F = 200\text{A}$	1.06		
		$I_F = 100\text{A}, T_J = 125^\circ\text{C}$	.76		
$I_{RM}$	Maximum Reverse Leakage Current	$V_R = 200\text{V}$		2	mA
		$V_R = 200\text{V}, T_J = 125^\circ\text{C}$		40	
$C_T$	Junction Capacitance, $V_R = 200\text{V}$		470		pF

### DYNAMIC CHARACTERISTICS

APT2X101S20J

Symbol	Characteristic	Test Conditions	MIN	TYP	MAX	UNIT
$t_{rr}$	Reverse Recovery Time	$I_F = 100A, di_F/dt = -200A/\mu s$ $V_R = 133V, T_C = 25^\circ C$	-	70		ns
$Q_{rr}$	Reverse Recovery Charge		-	240		nC
$I_{RRM}$	Maximum Reverse Recovery Current		-	6	-	Amps
$t_{rr}$	Reverse Recovery Time	$I_F = 100A, di_F/dt = -200A/\mu s$ $V_R = 133V, T_C = 125^\circ C$	-	110		ns
$Q_{rr}$	Reverse Recovery Charge		-	690		nC
$I_{RRM}$	Maximum Reverse Recovery Current		-	11	-	Amps
$t_{rr}$	Reverse Recovery Time	$I_F = 100A, di_F/dt = -700A/\mu s$ $V_R = 133V, T_C = 125^\circ C$	-	95		ns
$Q_{rr}$	Reverse Recovery Charge		-	1750		nC
$I_{RRM}$	Maximum Reverse Recovery Current		-	32		Amps

### THERMAL AND MECHANICAL CHARACTERISTICS

Symbol	Characteristic / Test Conditions	MIN	TYP	MAX	UNIT
$R_{\theta JC}$	Junction-to-Case Thermal Resistance			.33	$^\circ C/W$
$V_{Isolation}$	RMS Voltage (50-60Hz Sinusoidal Waveform from Terminals to Mounting Base for 1 Min.)	2500			Volts
$W_T$	Package Weight		1.03		oz
			29.2		g
Torque	Maximum Terminal & Mounting Torque			10	lb•in
				1.1	N•m

Microsemi reserves the right to change, without notice, the specifications and information contained herein.

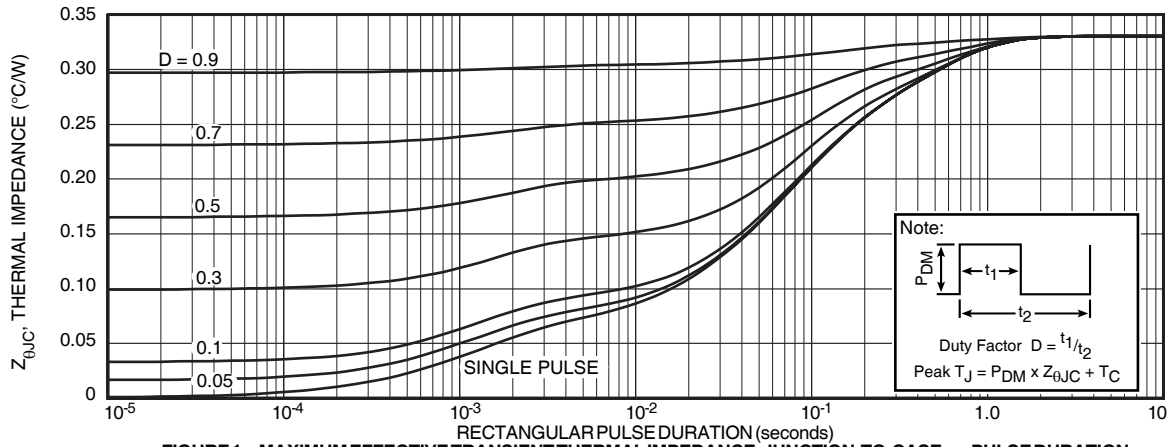

FIGURE 1a. MAXIMUM EFFECTIVE TRANSIENT THERMAL IMPEDANCE, JUNCTION-TO-CASE vs. PULSE DURATION

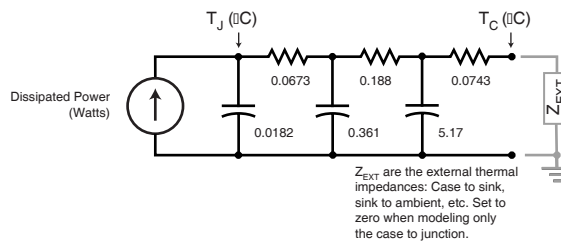

FIGURE 1b. TRANSIENT THERMAL IMPEDANCE MODEL

# TYPICAL PERFORMANCE CURVES

APT2X101S20J

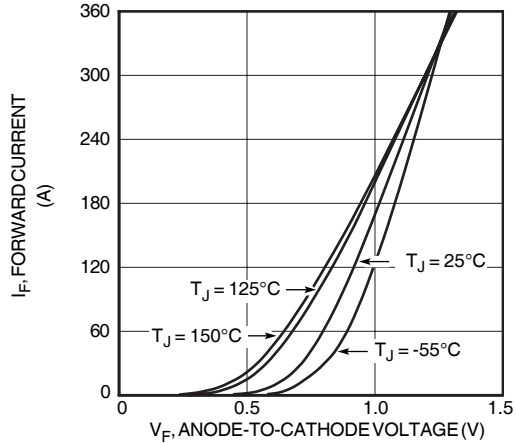

Figure 2. Forward Current vs. Forward Voltage

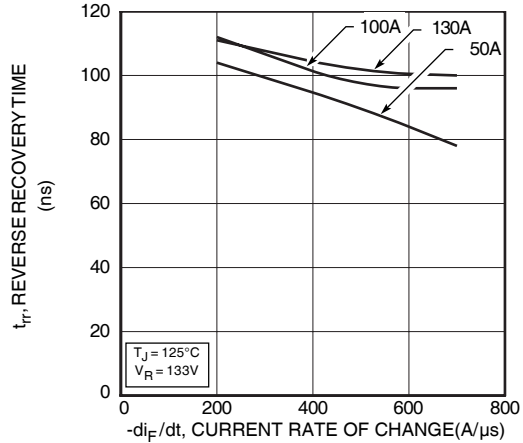

Figure 3. Reverse Recovery Time vs. Current Rate of Change

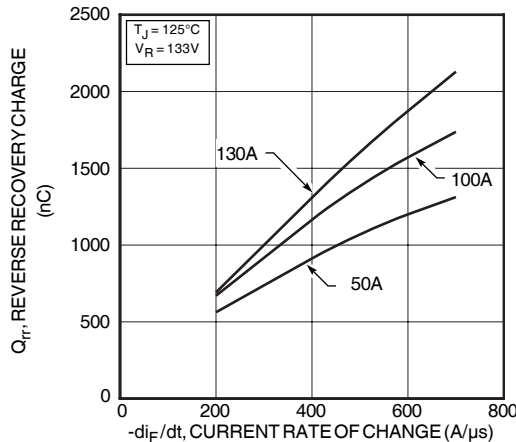

Figure 4. Reverse Recovery Charge vs. Current Rate of Change

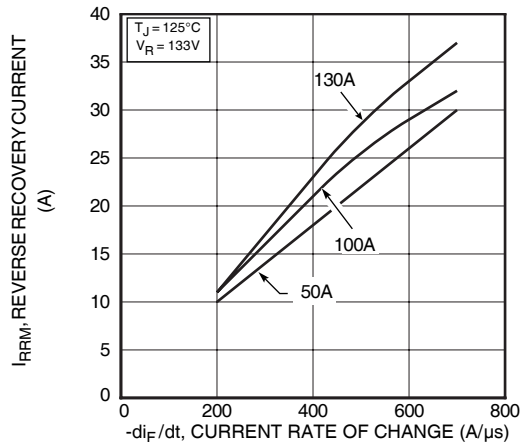

Figure 5. Reverse Recovery Current vs. Current Rate of Change

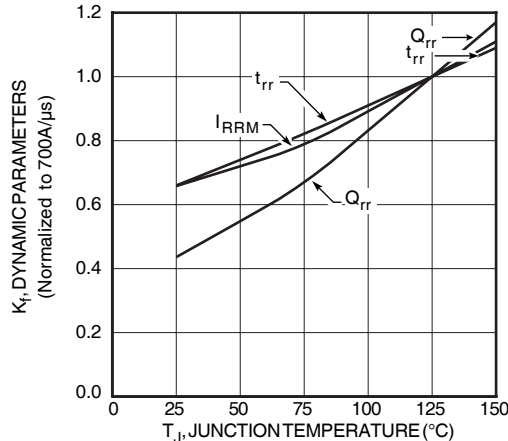

Figure 6. Dynamic Parameters vs. Junction Temperature

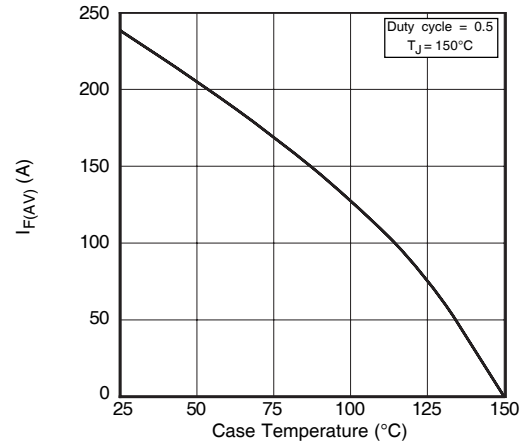

Figure 7. Maximum Average Forward Current vs. Case Temperature

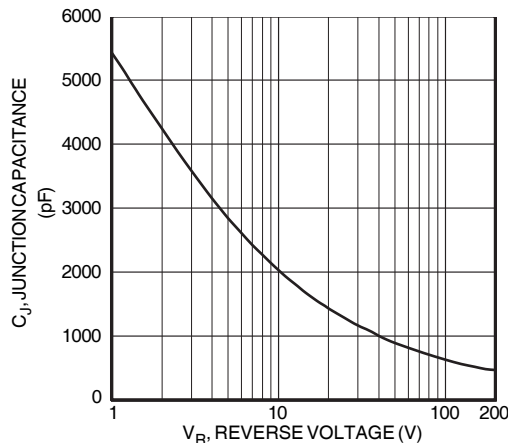

Figure 8. Junction Capacitance vs. Reverse Voltage

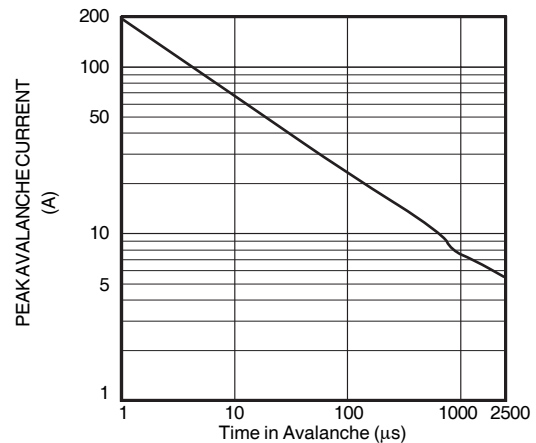

Figure 9. Single Pulse UIS SOA

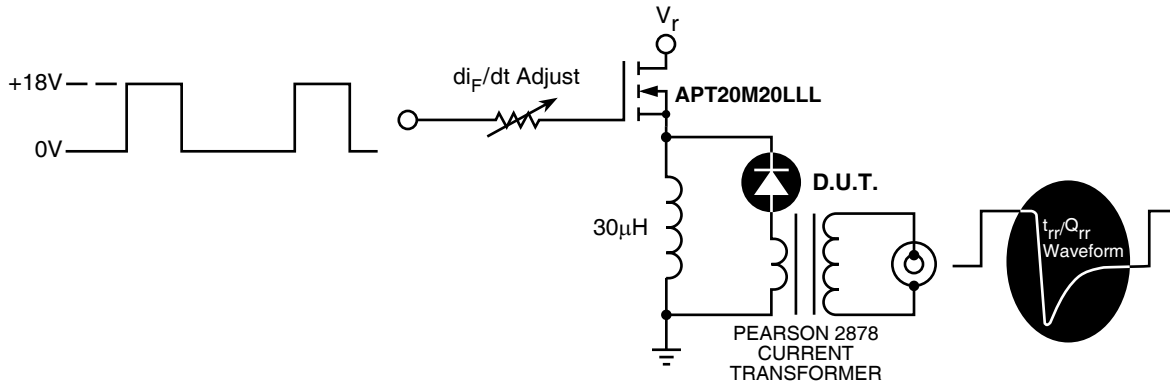

Figure 9. Diode Test Circuit

- 1  $I_F$  - Forward Conduction Current
- 2  $di_F/dt$  - Rate of Diode Current Change Through Zero Crossing.
- 3  $I_{RRM}$  - Maximum Reverse Recovery Current.
- 4  $t_{rr}$  - Reverse Recovery Time, measured from zero crossing where diode current goes from positive to negative, to the point at which the straight line through  $I_{RRM}$  and  $0.25 \cdot I_{RRM}$  passes through zero.
- 5  $Q_{rr}$  - Area Under the Curve Defined by  $I_{RRM}$  and  $t_{rr}$ .

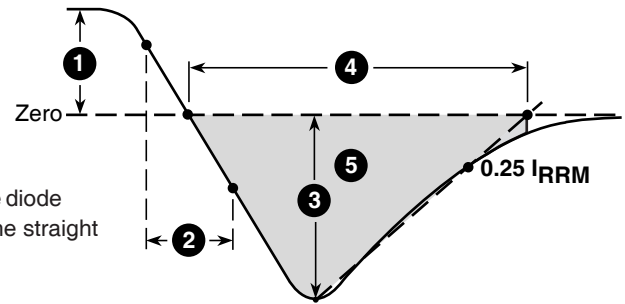
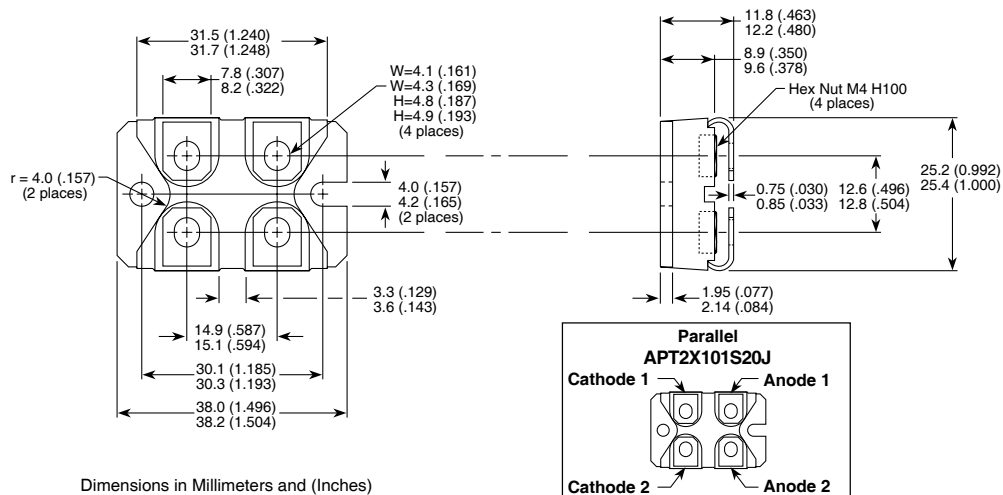

Figure 10, Diode Reverse Recovery Waveform and Definitions

SOT-227 Package Outline



Dimensions in Millimeters and (Inches)