



# Złącze AK700/3-5.0-V 3 PIN RoHS rozstaw 5mm CE PTR Messtechnik



## Dane techniczne:

Nazwa: AK700/3-5.0-V

Liczba pinów: 3

Zacisk: śrubowy, docisk

Przekrój przewodu: max 4mm<sup>2</sup>

Prąd znamionowy: 24A

Napięcie znamionowe: 250V

Rozstaw: 5mm

Temperatura pracy: -30...105°C

Producent: PTR Messtechnik



**PTR**

A Phoenix Mecano Company

**AK(Z) 700 VERTICAL**

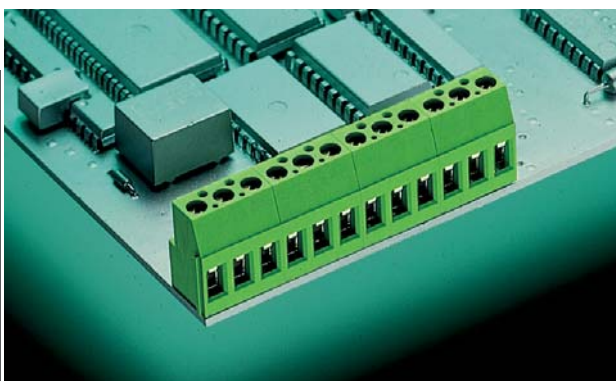

**AK(Z) 700/.. - 5.0 (5.08) - V - GREEN**

**2-12 poles, Spacing 5,0 mm and 5,08 mm  
insert required no. of poles ..**

How to order see page 11

**AK(Z) 700 HORIZONTAL**

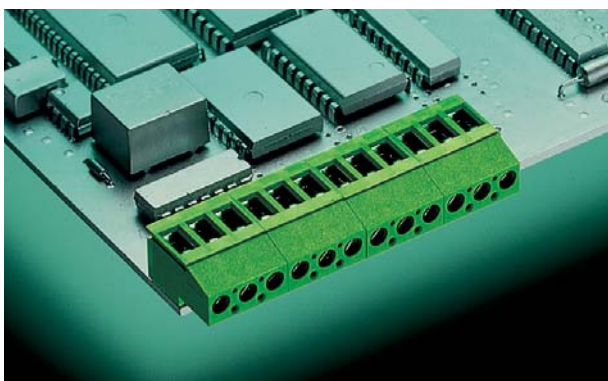

**AK(Z) 700/.. - 5.0 (5.08) - H - GREEN**

**2-12 poles, Spacing 5,0 mm and 5,08 mm  
insert required no. of poles ..**

How to order see page 11

**Ratings:**



Rated Voltage	300 V	250 V
Rated Current	20 A	24 A (T60)
Wire Size	AWG 30-12	2,5 mm <sup>2</sup>
Test Voltage		2,0 kV
Rated Torque / Screw Size		0,5 Nm/M3

**Max. Rated Cross Section**

Single Wired (solid)	4,0 mm <sup>2</sup>
Stranded Wire (flexible)	2,5 mm <sup>2</sup>
Stranded wire with Ferrules	2,5 mm <sup>2</sup>

**Dimensions**

Spacing	5,0 mm (5,08 mm)
PCB Hole Diameter	1,3 mm
Stripped Length	8,0 mm

**Materials**

Insulating Material	PA
Flammability Class	UL94 V-0
Temperature Range	-30°C/+105°C
Terminal Block	CuZn
Wire Guard	Cu
Colour	green
	RAL 6018

**Ratings:**



Rated Voltage	300 V	250 V
Rated Current	15 A	24 A (T60)
Wire Size	AWG 22-14	2,5 mm <sup>2</sup>
Test Voltage		2,0 kV
Rated Torque / Screw Size		0,5 Nm/M3

**Max. Rated Cross Section**

Single Wired (solid)	4,0 mm <sup>2</sup>
Stranded Wire (flexible)	2,5 mm <sup>2</sup>
Stranded wire with Ferrules	2,5 mm <sup>2</sup>

**Dimensions**

Spacing	5,0 mm (5,08 mm)
PCB Hole Diameter	1,3 mm
Stripped Length	8,0 mm

**Materials**

Insulating Material	PA
Flammability Class	UL94 V-0
Temperature Range	-30°C/+105°C
Terminal Block	CuZn
Wire Guard	Cu
Colour	green
	RAL 6018

**AK(Z) 700 VERTICAL**

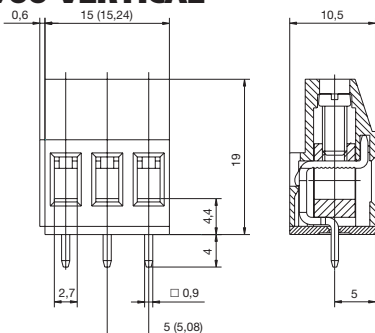

**AK(Z) 700 HORIZONTAL**

