

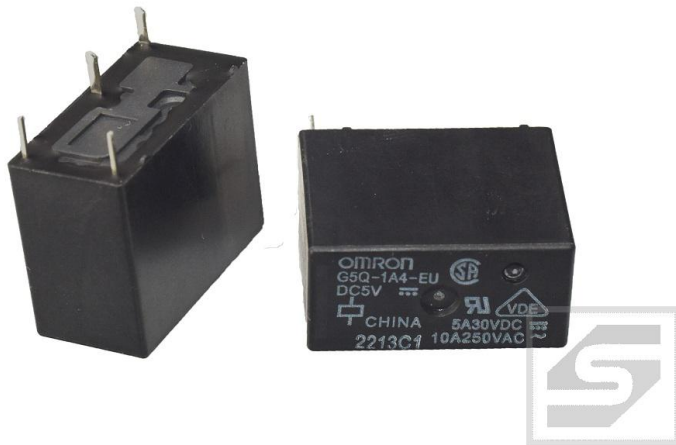

Przełącznik G5Q-1A4-EU 5VDC;SPST-NO U cewki:5VDC;10A/250VAC;OMRON; RoHS



Dane techniczne:

Nazwa: G5Q-1A4-EU 5VDC

Konfiguracja styków: SPST-NO

Napięcie cewki nominalne: 5V DC

Obciążalność styków AC (przy obciążeniu rezystancyjnym): 10A / 250V AC

Obciążalność styków DC (przy obciążeniu rezystancyjnym): 5A / 30V DC

Prąd styków maks.: 10A

Napięcie przełączane: max. 30V DC, max. 277V AC

Montaż: PCB

Rezystancja cewki: 125Ω

Czas zadziałania: 10ms

Wymiary zewnętrzne: 20,3x10,3x15,8mm

Czas zwolnienia: 5ms

Pobór mocy przez cewkę: 200mW

Temperatura pracy: -40...85°C

Rezystancja styków: 100mΩ

Raster wyprowadzeń: 2,54mm

Prąd cewki: 40mA

Opis obudowy: uszczelnienie hermetyczne

Producent: OMRON

www.podzespoly-elektroniczne.pl

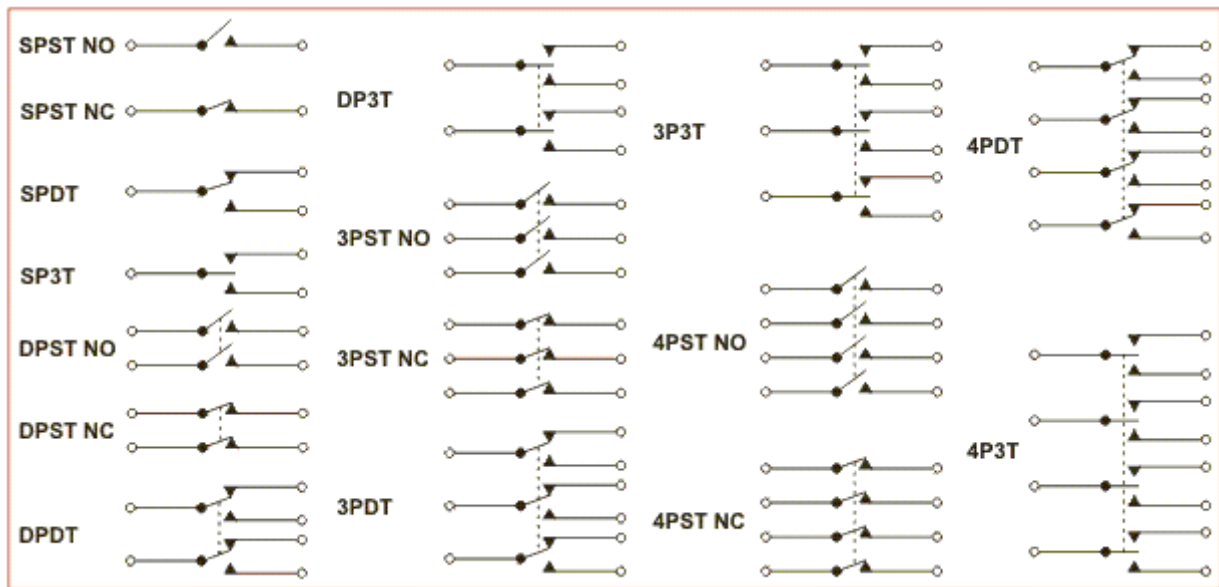

Compact, High Isolation Relay

- Compact single pole relay with high isolation between coil and contacts.
- Up to 10 A 250 VAC switching on the NO contacts.
- Ensures a withstand impulse voltage of 8,000 V between the coil and contacts.
- Low coil power consumption (SPST-NO: 200 mW, SPDT: 400 mW).
- UL class F coil insulation.
- UL, CSA and EN approvals.
- Ideal for appliance and HVAC controls.
- Tracking resistance: CTI > 250.
- Contains no lead inside and features cadmium-free contacts ensuring environmentally friendly use.



Ordering Information

To Order: Select the part number and add the desired coil voltage rating (e.g. G5Q-14-EU-DC12)

Classification		Enclosure rating	Part number
Single contact, Class F coil	SPST-NO	Vented	G5Q-1A-EU
		Sealed	G5Q-1A4-EU
	SPDT	Vented	G5Q-1-EU
		Sealed	G5Q-14-EU

Specifications

Coil Ratings

Rated voltage (V)		Rated current	Coil resistance (Ω)	Pick-up voltage	Drop-out Voltage	Maximum voltage	Power consumption (mW)
SPDT	DC5	80	63	75% of max.	5% of max.	190% at 23°C	400
	DC12	33.3	360				
	DC24	16.7	1440				
SPST-NO	DC5	40	125				200
	DC12	16.7	720				
	DC24	8.3	2880				

Note: Rated current and coil resistance are measured at 23°C with a tolerance of 10%.

Contact Rating

Load	SPDT	SPDT-NO
Rated load (resistive)	10A at 250 VAC (NO) 3A at 250 VAC (NO) 3A at 125 VAC (NO) 5A at 30 VDC (NO) 3A at 250 VDC (NC) 3A at 125 VDC (NC) 3A at 30 VDC (NC)	10A at 250 VAC 3A at 250 VAC 3A at 125 VAC 5A at 30 VDC
Contact material	Ag Alloy	
Rated carry current	AC 10 A – DC 5A (NO)/ AC 3A – DC 3A (NC)	
Max. switching voltage	277 VAC, 30 VDC	
Max. switching current	AC: 10 A (NO)/3 A (NC) DC: 5 A (NO)/3 A (NC)	
Max. switching capacity	2500 VA, 150 W (NO) 750 VA, 90 W (NC)	
Min. permissible load	10 mA at 5 VDC (P level: $\lambda_{60} = 0.1 \times 10^{-6}$ operation)	

Characteristics

Contact resistance (see note 2)	100 mΩ max.
Operate time	10 ms max.
Release time	5 ms max.
Insulation resistance (see note 3)	1,000 MΩ min.
Dielectric strength	4,000 VAC, 50/60 Hz for 1 min between coil and contacts 1000 VAC, 50/60 Hz for 1 min between contacts of same polarity
Impulse withstand voltage	8 kV (1.2 x 50 ms) between coil and contacts
Vibration resistance	Destruction: 10 to 55 Hz, 1.5-mm double amplitude for 2 hours Malfunction: 10 to 55 Hz, 1.5-mm double amplitude for 5 minutes
Shock resistance	Destruction: 1,000 m/s ² (approx. 100G) Malfunction: 100 m/s ² (approximately 10G)
Life expectancy (see note 4)	Mechanical 10,000,000 operations (18,000 operations per hour) Electrical 200,000 operations: 3 A (NO)/3 A (NC) at 125 VAC resistive load 100,000 operations: 3 A (NO)/3 A (NC) at 250 VAC 5 A (NO)/3 A (NC) at 30 VDC resistive load 25,000 operations: 10A (NO) at 250 VAC (900 operations per hour: 1 sec ON/3 sec OFF) Switching frequency: 1,800 operations per hour: 1 sec ON/1 SEC OFF
Ambient temperature	Operating & storage: -40°C to 85°C (with no icing)
Ambient humidity	Operating & storage: 5% to 85%

Note: 1. The data shown above are initial value.

2. The contact resistance is possible with 1 A applied at 5 VDC using a fall-of-potential method.

3. The insulation resistance is possible between coil and contacts and between contacts of the same polarity at 500 VDC.

4. The electrical life data items shown are possible at 23°C.

Approved Standards

UL508 (File No. E41515)

CSA C22.2 No. 14 (File No. LR31928)

Model	Coil ratings	Contact ratings	
		NO contacts	NO contacts
G5Q-EU	5-48 VDC	10 A, 250 VAC resistive 10 A, 30 VDC resistive 4 A, 120 VAC resistive, 100,000 ops. 4 FLA, 4 LRA 120 VAC, definite purpose, 100,000 operations.	3 A, 250 VAC resistive 3 A, 30 VDC resistive 4 LRA, 2 FLA, 120 VAC definite purpose, 100,000 operations.

Note: Ratings for both NO contacts and NC contacts are given at 85°C (221°F).

EN

Model	Coil ratings	Contact ratings
G5Q-EU	5,12, 24 VDC	10 A, 250 VAC $\cos\phi=1$ (NO) 5 A, 30 VDC L/R=0ms (NO) 3 A, 30 VDC L/R=0ms (NC)

Engineering Data

AMBIENT TEMPERATURE VS. MAXIMUM VOLTAGE

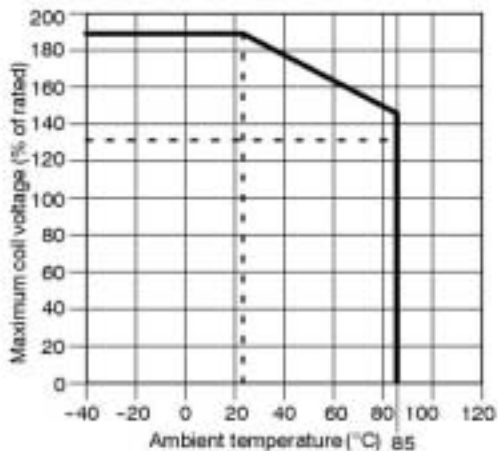

AMBIENT TEMPERATURE VS. RATED CARRY CURRENT

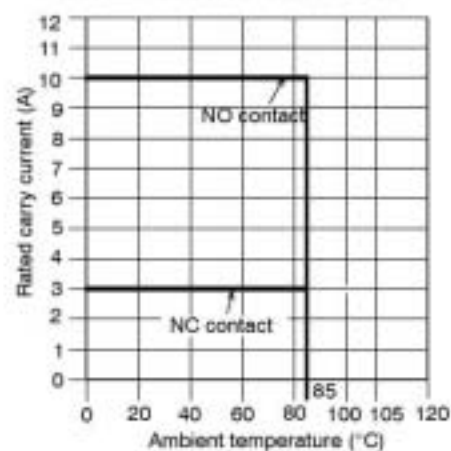

MAX. SWITCHING CAPACITY

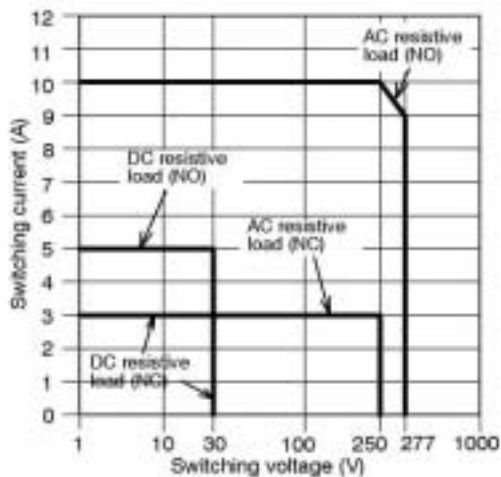

Dimensions

Note: All units are in millimeters unless otherwise indicated.

■ G5Q-EU SPDT

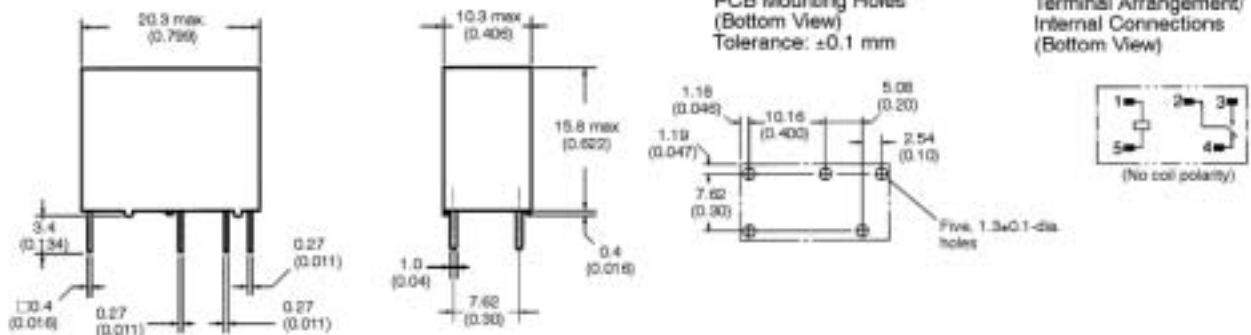

■ SPST-NO

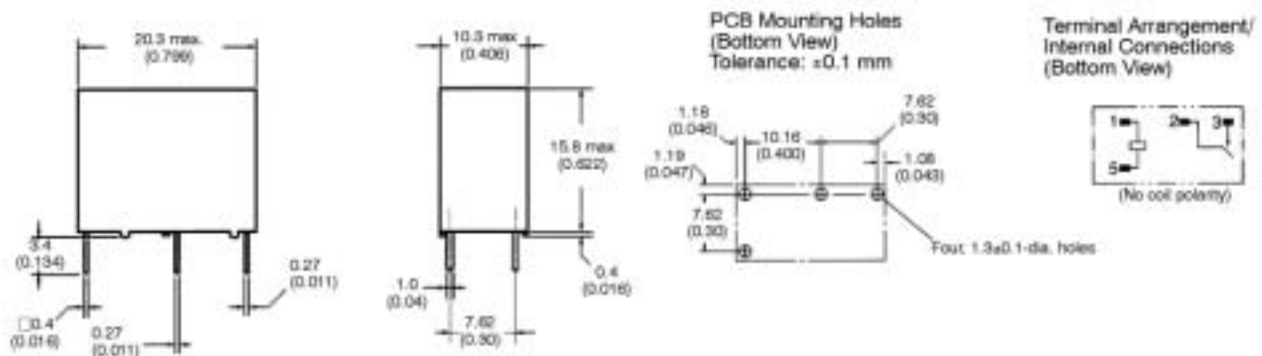

Precautions



CAUTION

Do not touch the terminals of the relay or the charted part of the socket when power is supplied to the Relay. Otherwise, an electric shock may occur.

ALL DIMENSIONS SHOWN ARE IN MILLIMETERS.

To convert millimeters into inches, multiply by 0.03937. To convert grams into ounces, multiply by 0.03527.

Cat. No. G5Q-EU In the interest of product improvement, specifications are subject to change without notice.

OMRON

Omron Electronic Components Europe BV

Wegalaan 57
2132 JD Hoofddorp
The Netherlands
Tel: +31 23 568 1200
Fax: +31 23 568 1212