

AM - Receiver Circuit

Description

This is an efficient bipolar monolithic circuit to apply in battery - powered or mains - operated radio receivers up to 30 MHz. It contains controlled RF stage, mixer, separated oscillator and regulated multistage IF amplifier.

Features

- symmetrical structured circuitry
- controlled RF prestage
- multiplicative balanced mixer, separated oscillator
- very well implemented large - signal characteristic begins already from 4.5 V supply voltage
- terminals for indicating instrument
- controlled IF amplifier implementing 60 dB control range
- external demodulator (diode)
- wide range of supply voltage between 4.5 and 15 V

Package

TCA 440 • DIP 16

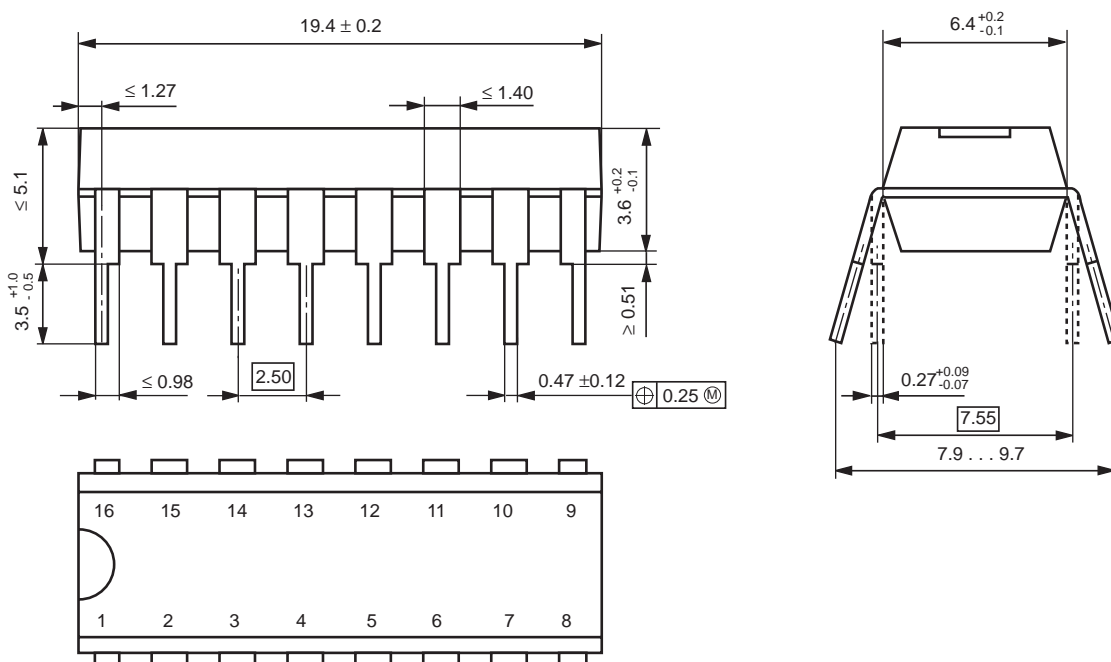

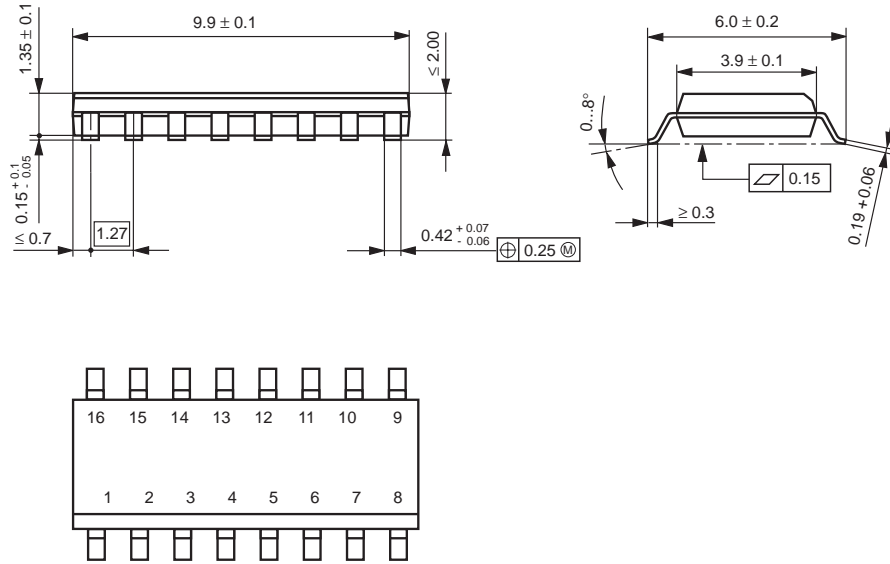

Pin configuration

- | | | | |
|---|----------------------------|----|---------------------------------------|
| 1 | RF prestage, input 1 | 9 | input IF control amplifier |
| 2 | RF prestage, input 2 | 10 | indicator output IF control amplifier |
| 3 | RF control amplifier input | 11 | IF blocking |
| 4 | oscillator circuit pin 1 | 12 | input IF amplifier |
| 5 | oscillator circuit pin 2 | 13 | IF blocking |
| 6 | oscillator circuit pin 3 | 14 | supply voltage |
| 7 | IF output | 15 | mixer output 1 |
| 8 | ground | 16 | mixer output 2 |

Block diagram

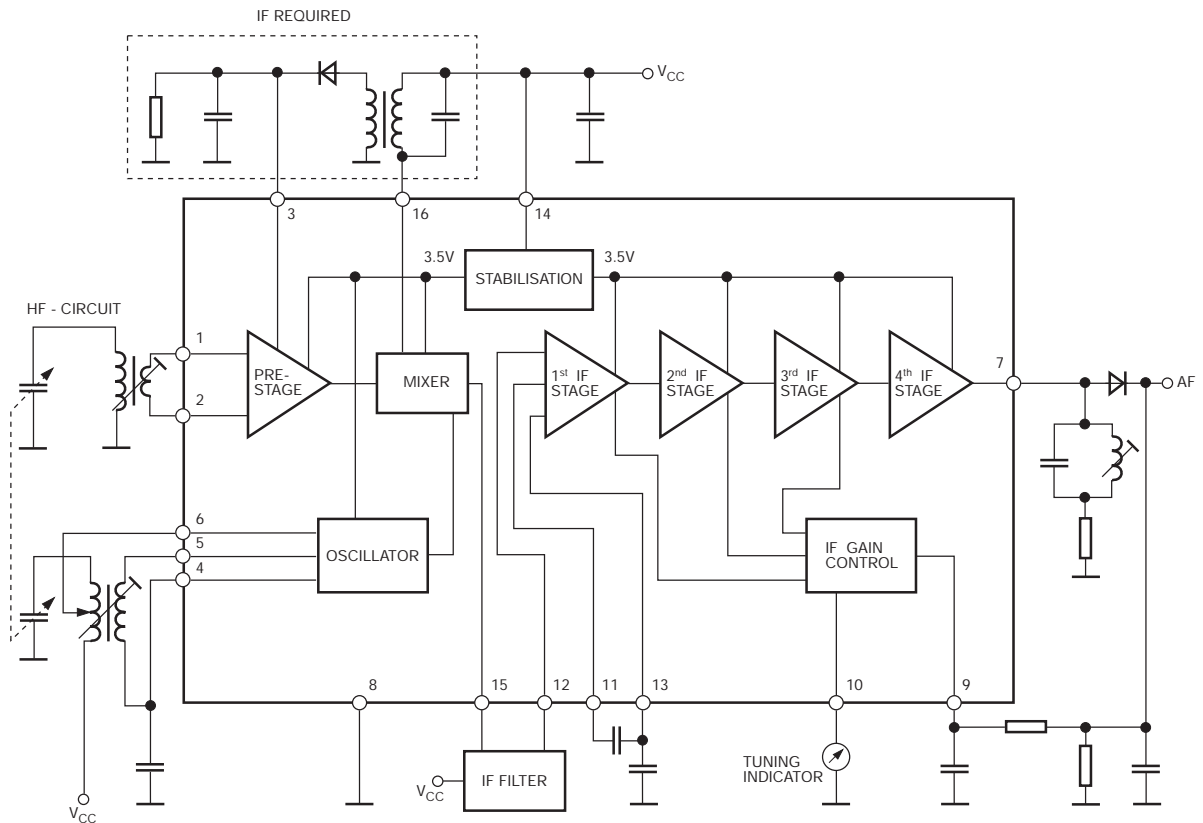

Functional description

It contains several function units, which enable designing and assembling of efficient AM tuners. Caused by internal voltage stabilization characteristics are rather independent from supply voltage.

The RF input signal reaches via a controllable and overdriving proof preselector stage a balanced mixer. By means of a RF - signal generated by a separated oscillator the input signal is transported into IF. Multiplicative mixing causes only few harmonic content. Gain control is carried out by means of two separated feedback control loops for preselector stage and IF amplifier. By these a loop bandwidth of approximately 100 dB is obtained. The control voltage of the IF - amplifier can be used to drive a moving - coil instrument (field strength indicator). The IF amplifier consists of 4 amplifier stages, the first, second and third can be controlled. The bandwidth of the IF amplifier is approximately 2 MHz and on that account sufficient for usual IF frequencies in the AM range of approximately 460 kHz.

The symmetrical arrangement of the entire circuitry guarantees well oscillating. The bridge of the mixer avoids direct breakdown.

Absolute maximum ratings

		min	max	unit
Supply voltage	V_{CC}	4.5	15.0	V
Junction temperature	T_j		150	°C
Ambient operating temperature	T_a	-15	80	°C
Storage temperature	T_s	-40	125	°C
Total thermal resistance	R_{thja}		120	K/W

Recommended operational conditions

		min	max	unit
Supply voltage	V_{CC}	4.5	15	V
Ambient operating temperature	T_a	-10	70	°C

Characteristics

refer to application examples, $f_i = 1 \text{ MHz}$, $f_{osc} = 1.455 \text{ kHz}$, $f_{IF} = 455 \text{ kHz}$, $V_{CC} = 9 \text{ V}$, $f_m = 1 \text{ kHz}$, $m = 0.8$, voltages refer to ground, $T_a = 20 \text{ to } 25 \text{ }^\circ\text{C}$, unless specified otherwise

		min	typ	max	unit
<u>Current and voltage supply (no RF signal)</u>					
Supply voltage	V_{14-8}	4.5	9	15	V
Current consumption					
$V_{14-8} = 4.5 \text{ V}$	I_{14}		7		mA
$V_{14-8} = 9 \text{ V}$	I_{14}		10.5	16	mA
$V_{14-8} = 15 \text{ V}$	I_{14}		12		mA
<u>Entire receiver</u>					
RF level variation					
with $\Delta V_{NF} = 6 \text{ dB}$	ΔV_{RF}		65		dB
with $\Delta V_{NF} = 10 \text{ dB}$	ΔV_{RF}		80		dB
NF output voltages (symmetrically measured at 1-2)					
$V_{iHF} = 20 \text{ } \mu\text{V}$, $m = 0.8$	$V_{NF(rms)}$	60	140		mV
$V_{iHF} = 1 \text{ mV}$, $m = 0.8$	$V_{NF(rms)}$		260		mV
$V_{iHF} = 500 \text{ mV}$, $m = 0.8$	$V_{NF(rms)}$	100	350	560	mV
$V_{iHF} = 20 \text{ } \mu\text{V}$, $m = 0.3$	$V_{NF(rms)}$		50		mV
$V_{iHF} = 1 \text{ mV}$, $m = 0.3$	$V_{NF(rms)}$		100		mV
$V_{iHF} = 500 \text{ mV}$, $m = 0.3$	$V_{NF(rms)}$		130		mV
RF input sensitivity measured at $60 \text{ } \Omega$, $m = 0.3$, $R_G = 540 \text{ } \Omega$					
signal-to-noise ratio					
$S + N/N = 6 \text{ dB}$	V_{iRF}		1		μV
$S + N/N = 26 \text{ dB}$	V_{iRF}		7		μV
$S + N/N = 58 \text{ dB}$	V_{iRF}		1		mV
Maximum RF input voltage (THD = 10 %)	V_{iHF}			1.5	V
Total harmonic distortion					
$V_{HF} = 500 \text{ mV}$	THD		4.5	10	%
$V_{HF} = 30 \text{ mV}$	THD		2.8	8	%
<u>RF part</u>					
Input frequency range	f_{iHF}	0		50	MHz
Output frequency					
$f_{IF} = f_{osc} - f_{iHF}$	f_{IF}		455		kHz
Control range	ΔG_V		38		dB

		min	typ	max	unit
IF suppression between 1 - 2 and 15	a_{IF}		20		dB
RF input impedance unbalanced coupling					
V_{iHFmax}	Z_i		2 5		k Ω pF
V_{iHFmin}	Z_i		2.2 1.5		k Ω pF
balanced coupling					
V_{iHFmax}	Z_i		4.5		k Ω
V_{iHFmin}	Z_i		4.5 1.5		k Ω pF
Mixer output impedance (pin 15 or 16)	Z_o		250 4.5		k Ω pF
Steepness	S_{HF}		28		mS
<u>IF part</u>					
Input frequency range	f_{iIF}	0		2	MHz
Control range $f_{iIF} = 455$ kHz, $\Delta V_{NF} = 10$ dB	ΔG_V		62		dB
Start of control ($\Delta V_{iIF} / \Delta V_{NF} = 10$ dB / 3 dB)	V_{ctrlIF}		140		μ V
maximum IF input voltage ($THD_{NF} = 10$ %)	V_{iIFmax}		200		mV
NF output voltage applied to 60 Ω					
$V_{ZF} = 30$ μ V	$V_{NF(rms)}$		50		mV
$V_{ZF} = 3$ mV	$V_{NF(rms)}$		200		mV
$V_{ZF} = 3$ mV; $m = 0.3$	$V_{NF(rms)}$		70		mV
IF input impedance (unbalanced coupling)	Z_{iIF}		3 3		k Ω pF
IF output impedance (pin 7)	Z_o		200 8		k Ω pF

Indication instrument

Recommended indication instruments: 500 μ A ($R_i = 800$ Ω)
300 μ A ($R_i = 1.5$ k Ω)

For indication a voltage source of 600 mV (V_{EMF}) and an internal source impedance of 400 Ω is available.

Dependences

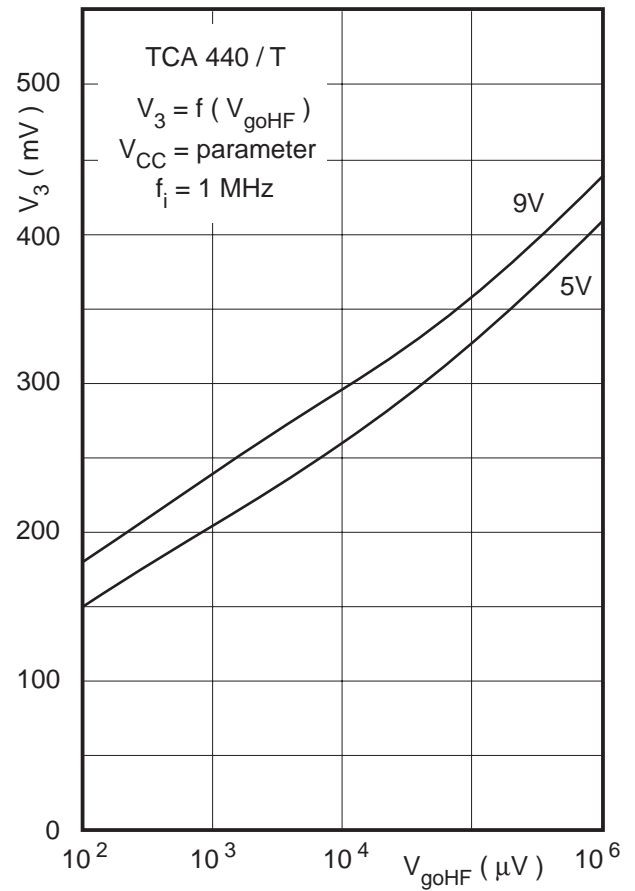
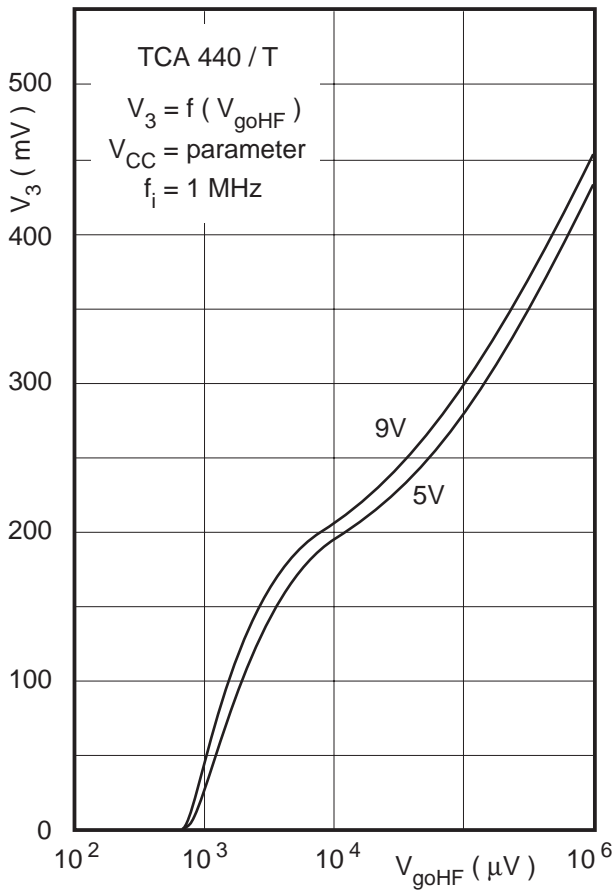
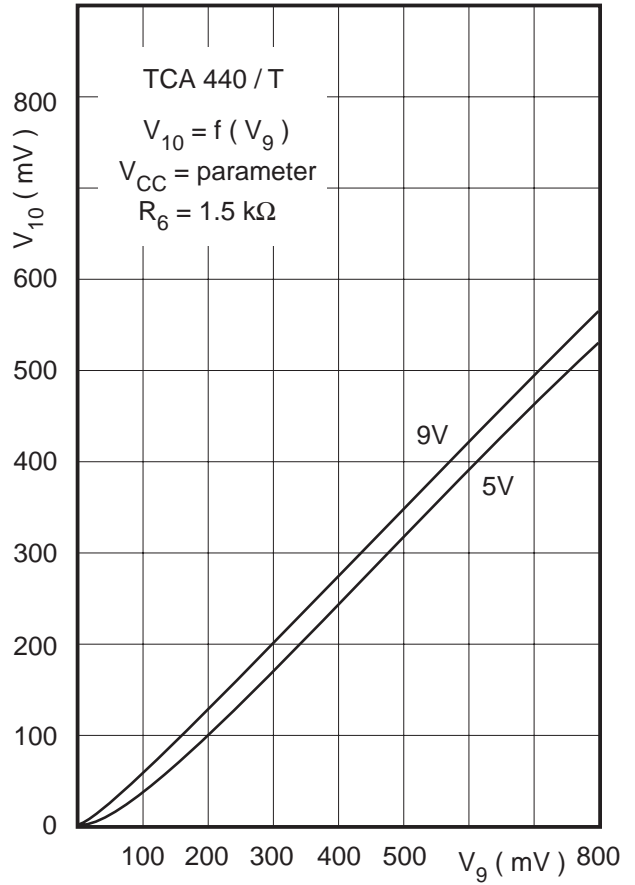
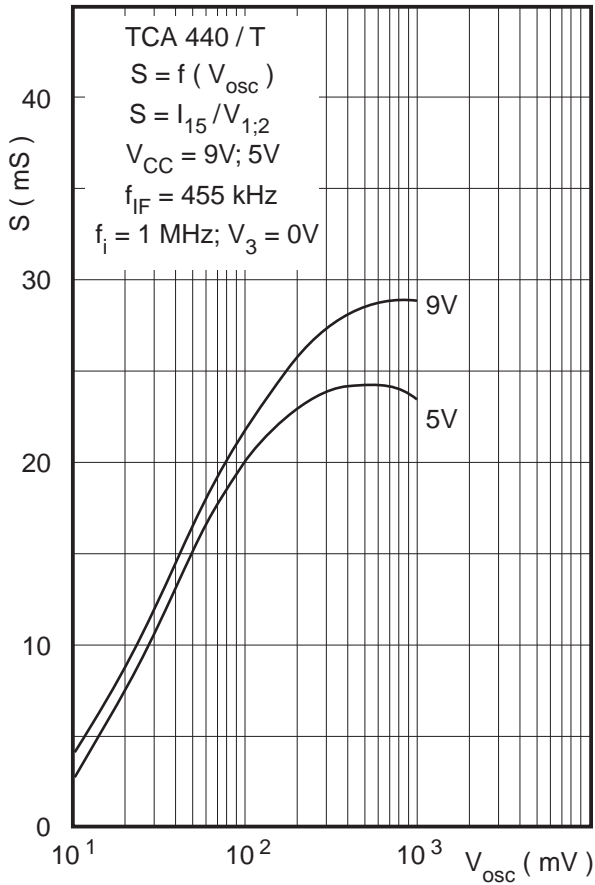

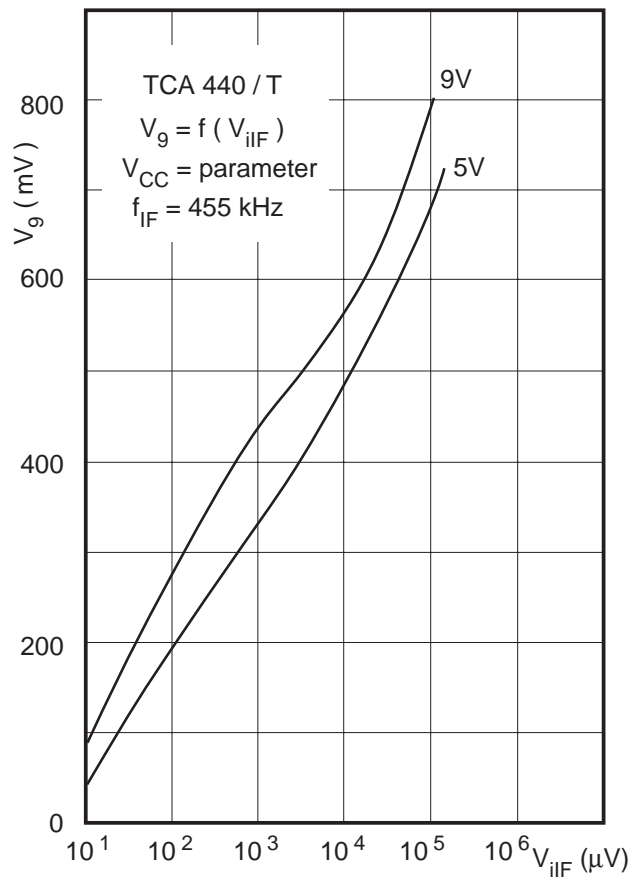
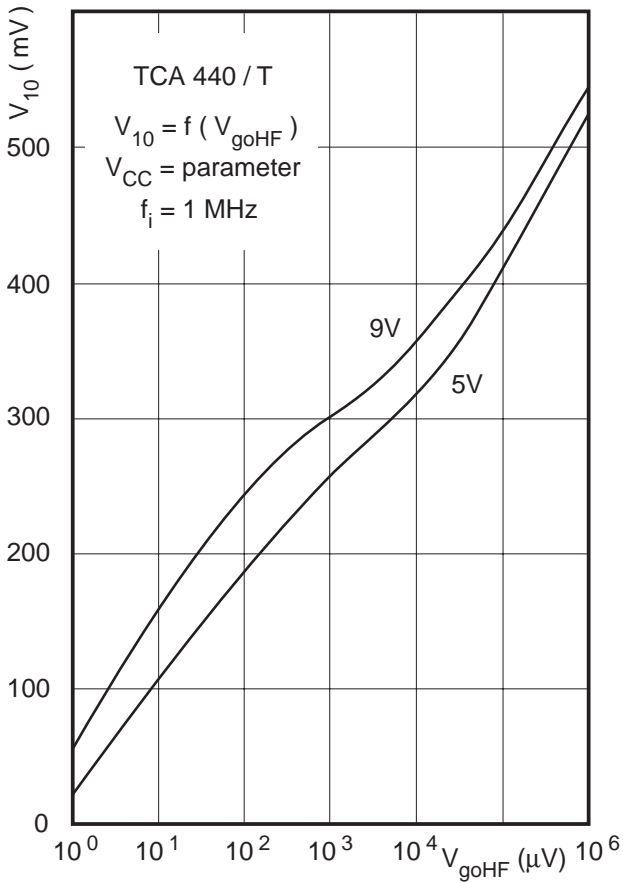
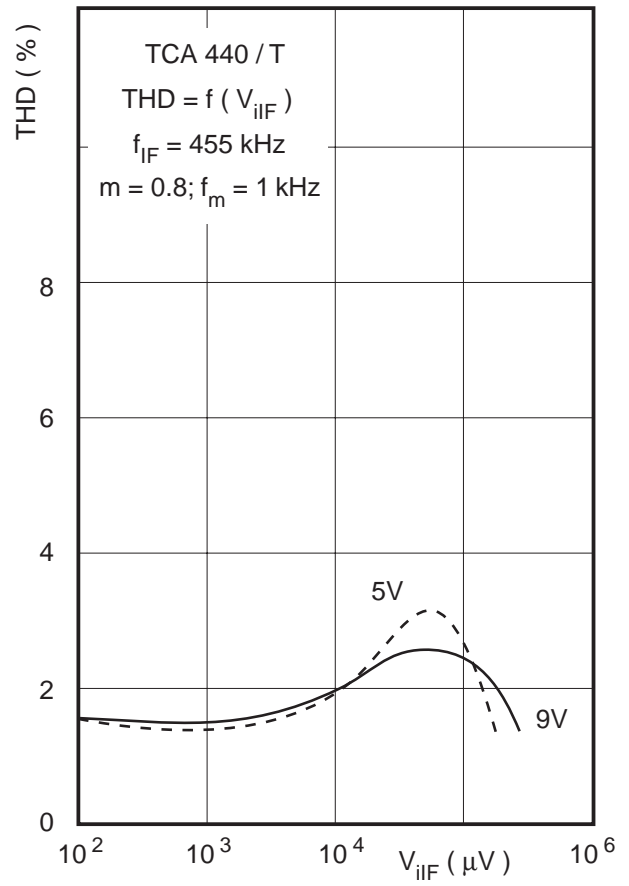
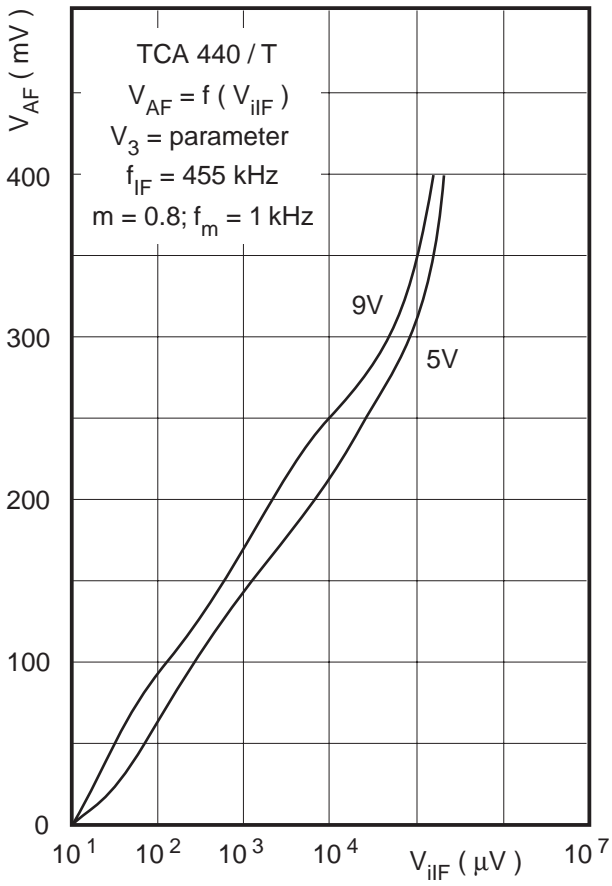

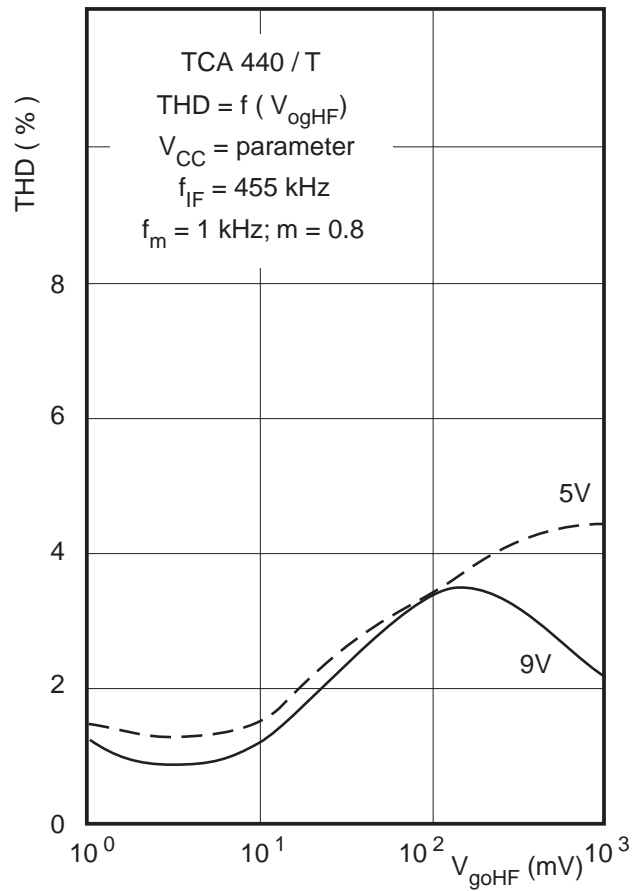
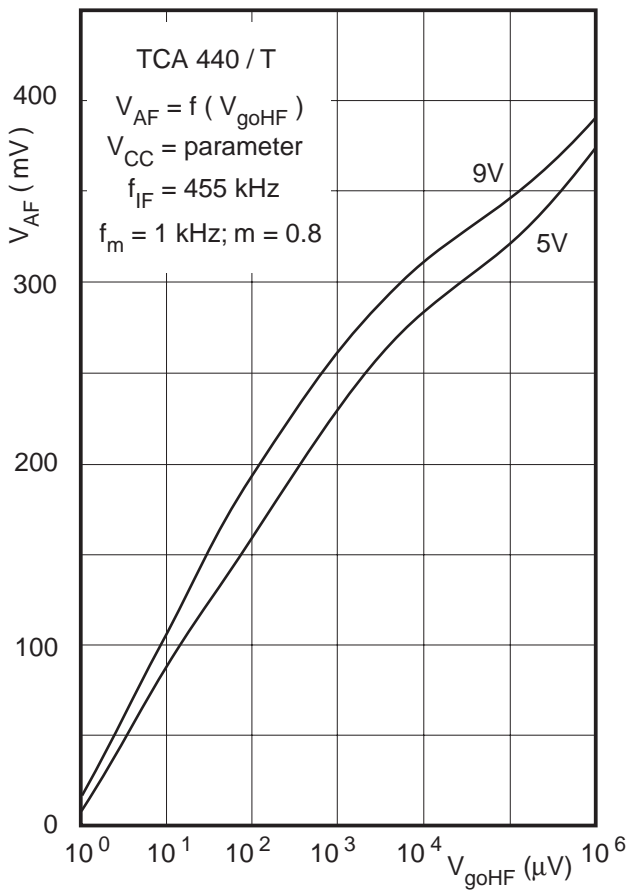
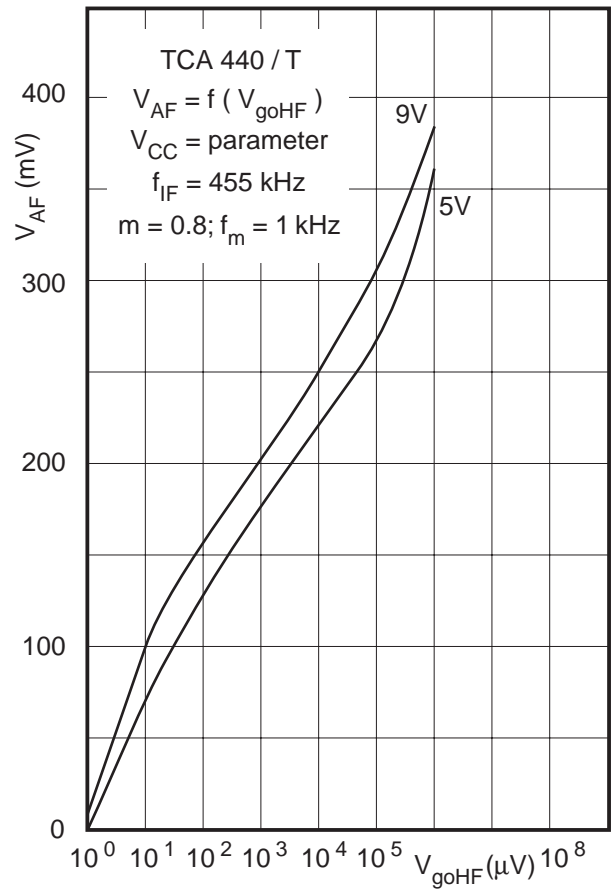
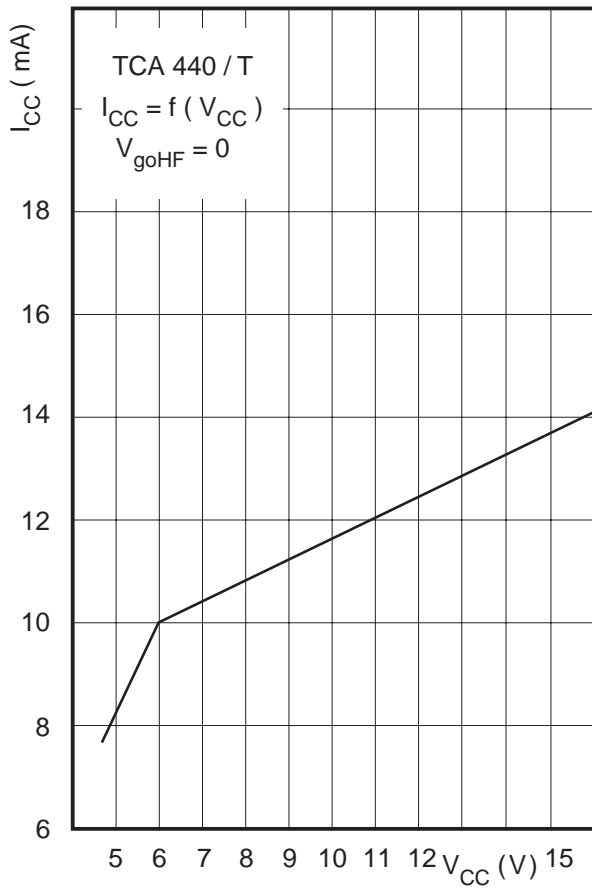

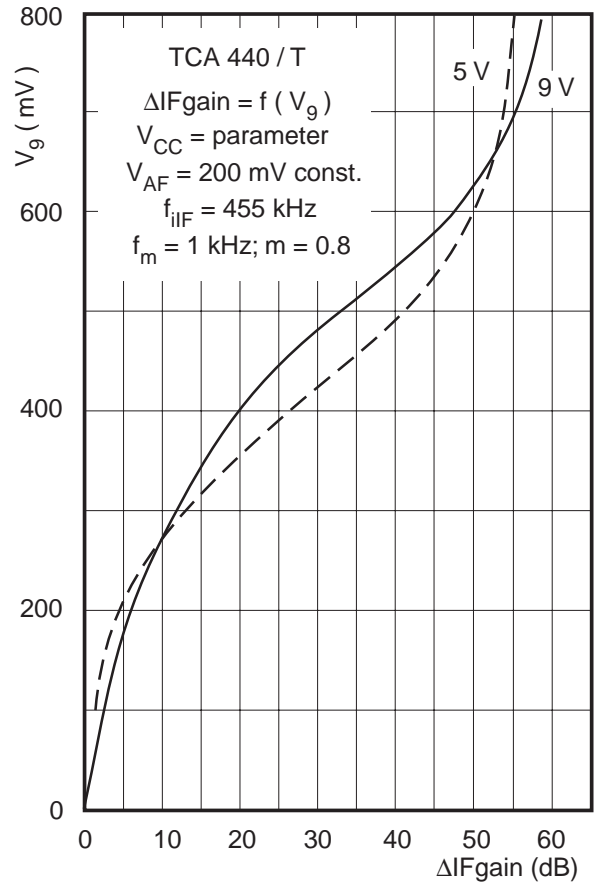
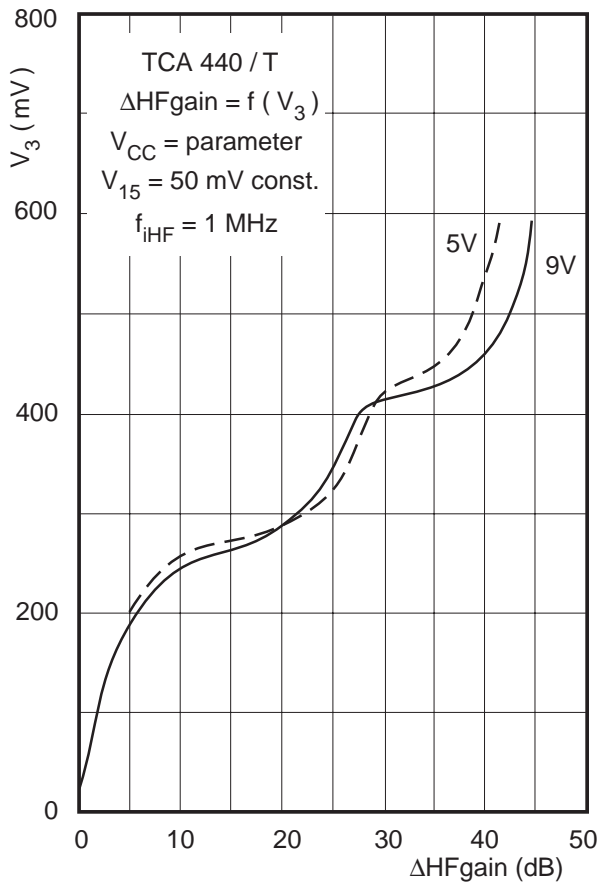
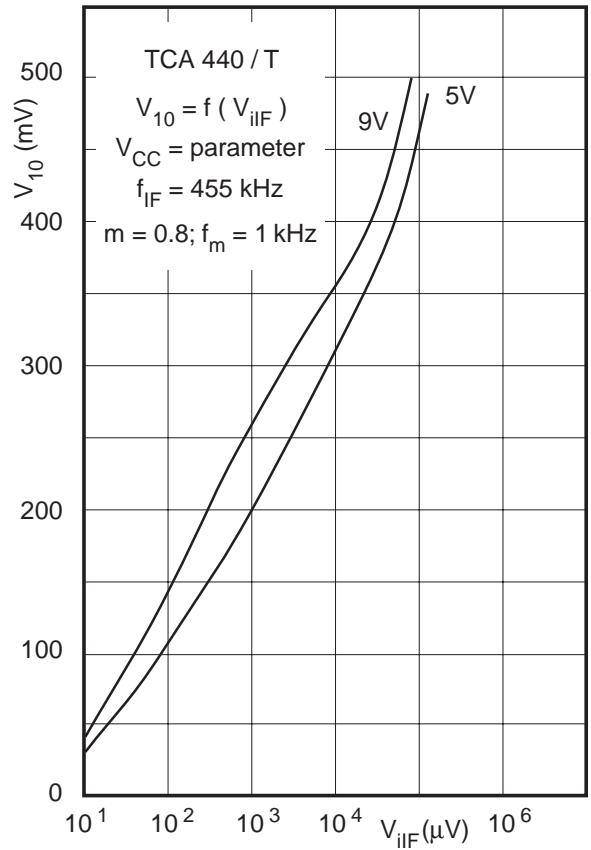
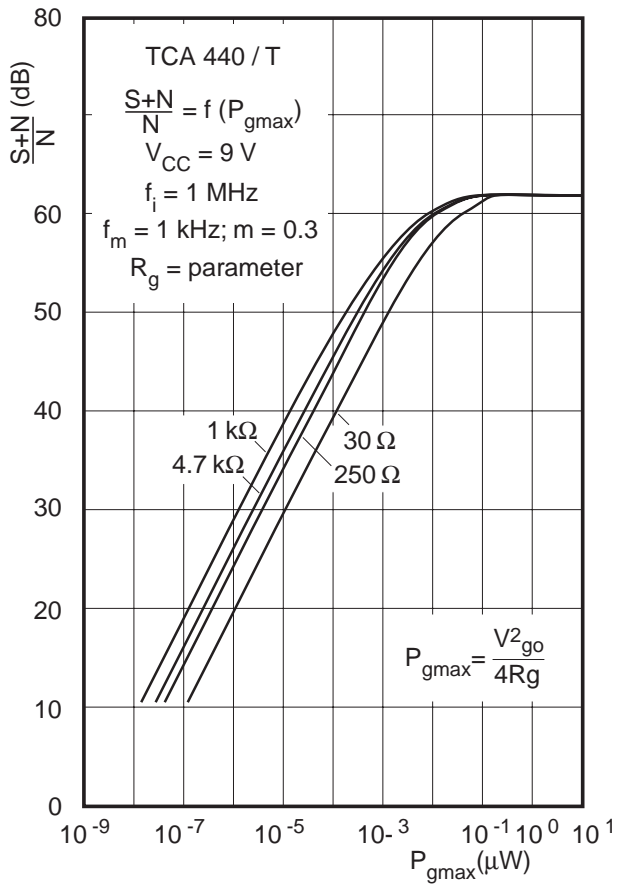

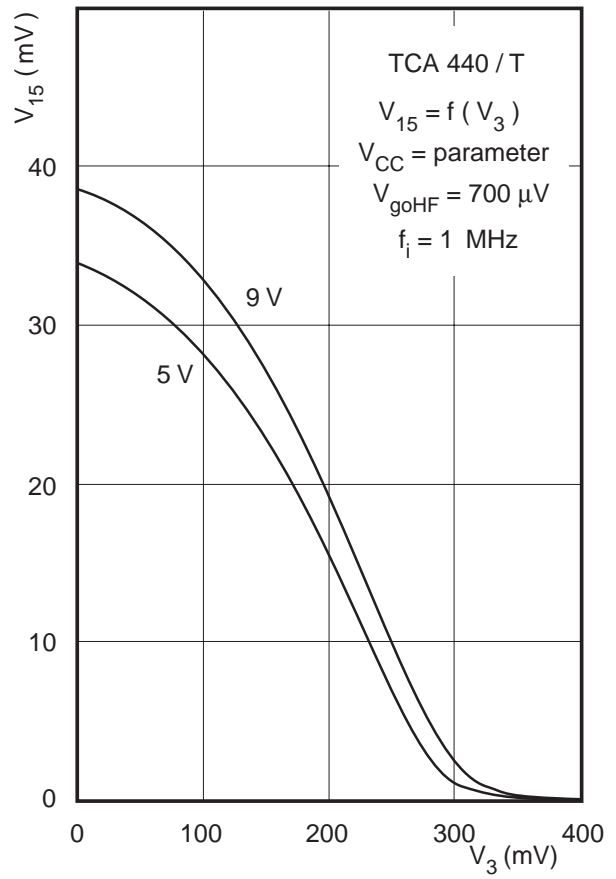
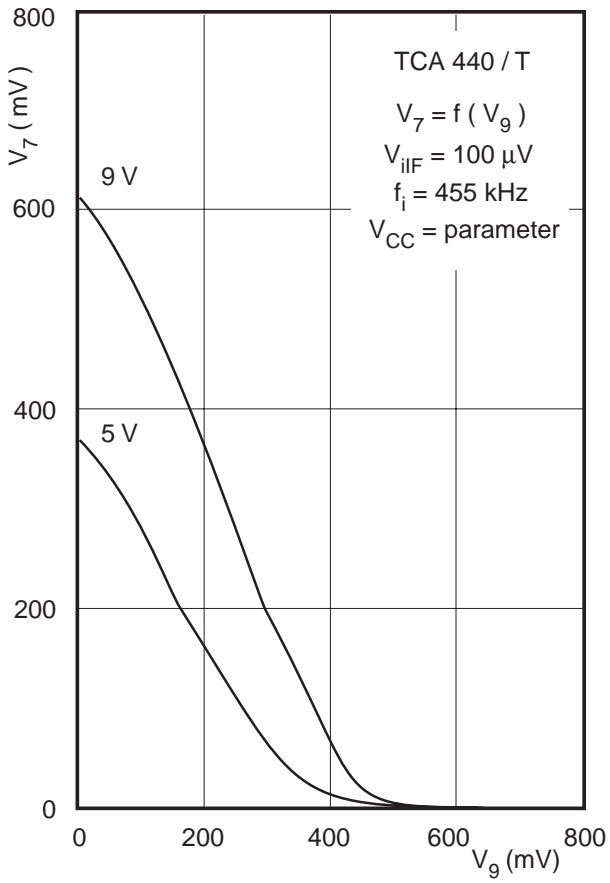

Application examples

- TCA 440

