

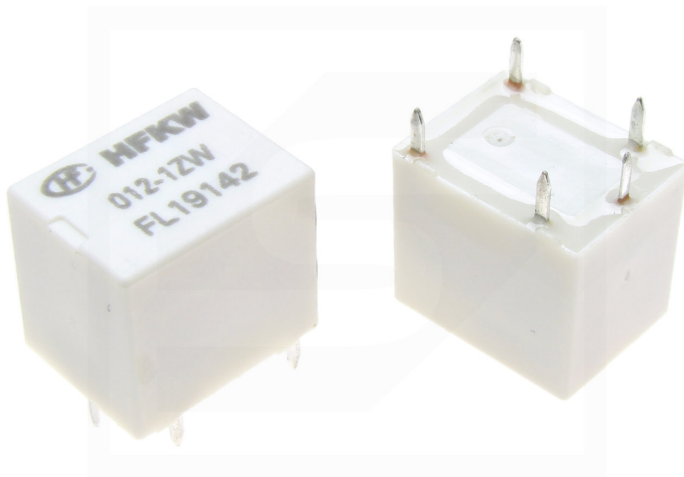

Przełącznik HFKW-012-1ZW; Hongfa; 1 st. przełączny; 25A; 12V DC;



Dane techniczne:

Nazwa: HFKW-012-1ZW

Wersja przełącznika: samochodowy

Konfiguracja styków: 1 styk przełączny

Napięcie cewki nominalne: 12VDC

Prąd styków maks. : 25A

Producent: HONGFA



Typical Applications

Central door lock, Mirror adjustment, Turning lamp control, Seat adjustment, Power door & windows, Speed-limit indicator control, Warm-up control, Wiper control

Features

- High current contact capacity (Carrying current: 35A/10min 25A/1h)
- Switching capacity up to 20A (at 85°C)
- Improved heat resistance
- High resistance to vibration and shock
- Reflow soldering version available
- RoHS & ELV compliant

CHARACTERISTICS

Contact arrangement	1A, 1C
Voltage drop (initial) ¹⁾	Typ.: 50mV (at 10A) Max. : 250mV (at 10A)
Contact rating	Resistive: 15A 13.5VDC Motor locked: 20A 13.5VDC Motor free: Break: 4A 13.5VDC Shock: 20A 13.5VDC
Max. carrying current ²⁾ (NO contact)	35A/10min 25A/1h
Max. switching current	NO/NC: 35/20A (at 16VDC)
Max. switching voltage	60VDC
Max. switching power	210W
Min.contact load	1A 6VDC
Electrical endurance	See " CONTACT DATA " table
Mechanical endurance	1 x 10 ⁷ OPS (300OPS/min)
Initial insulation resistance	100MΩ (at 500VDC)

Dielectric strength	500VAC (1min, leakage current less than 1mA)
Operate time	Max.: 10ms (at nomi. vol.)
Release time	Max.: 5ms ³⁾
Temperature rise (at nomi. vol.)	60K max.
Ambient temperature	-40°C to 85°C
Storage temperature	-40°C to 155°C
Vibration resistance	10Hz to 55Hz 1.5mm DA
Shock resistance	98m/s ²
Termination	PCB ⁴⁾
Construction	Wash tight, Flux proofed
Unit weight	Approx. 6g

- 1) Equivalent to the max. initial contact resistance is 100mΩ (1A 6VDC).
- 2) 25°C, measured when coil is energized with 100% nominal voltage.
- 3) The value is measured when voltage drops suddenly from nominal voltage to 0 VDC and coil is not paralleled with suppression circuit.
- 4) Since it is an environmental friendly product, please select lead-free solder when welding. The recommended soldering temperature and time is 240°C to 260°C, 2s to 5s.

CONTACT DATA ⁵⁾

at 23°C

Load voltage	Load type		Load current A			On/Off ratio		Electrical endurance OPS	Contact material	Load wiring diagram ⁴⁾	
			1C		1A	On s	Off s				
			NO	NC	NO						
13.5VDC	Resistive	Make	15	15	15	2	2	2×10 ⁵	AgSnO ₂ AgNi0.15	See diagram 1	
		Break	15	15	15						
	Resistive	Make	30	---	30	5	5	1×10 ⁵	AgSnO ₂	See diagram 2	
		Break	30	---	30						
	Motor Locked	Motor Locked	Make	25 ³⁾	---	25 ³⁾	2	2	1×10 ⁵	AgSnO ₂	See diagram 3
			Break	25 ³⁾	---	25 ³⁾					

Load voltage	Load type		Load current A			On/Off ratio		Electrical endurance OPS	Contact material	Load wiring diagram ⁴⁾
			1C		1A	On s	Off s			
			NO	NC	NO					
13.5VDC	Lamp ¹⁾	Make	90 ²⁾	---	90 ²⁾	1	9	1×10 ⁵ (at 85°C)	AgSnO ₂	See diagram 4
		Break	8.8	---	8.8					
	Lamp ¹⁾	Make	6×21W	---	6×21W	1	6	1×10 ⁵	AgSnO ₂	See diagram 4
		Break								
	Flasher	Make	3×21W	---	3×21W	0.365	0.365	2×10 ⁶	Special AgSnO ₂	See diagram 4
		Break								

1) When it is utilized in flasher, a special AgSnO₂ contact material should be used and the customer special code should be (170) as a suffix. Please connect by the polarity according to the diagram below.

2) Corresponds to the peak inrush current on initial actuation (cold filament).

3) Corresponds to the peak inrush current on initial actuation (motor).

4) The load wiring diagrams are listed below. When special AgSnO₂ contacts are applied, please heed the anode and cathode's request when wired.

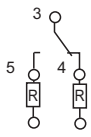

diagram 1

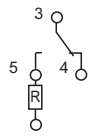

diagram 2

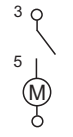

diagram 3

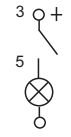

diagram 4

5) When the load requirement is different from content of the table above, please contact Hongfa for relay application support.

COIL DATA

at 23°C

Nominal voltage VDC	Pick-up voltage VDC		Drop-out voltage VDC	Coil resistance Ω	Power consumption W
	23°C	85°C			
6	3.6	4.5	0.5	60	0.6
9	5.4	6.8	0.7	135	0.6
10	6.3	7.9	0.8	180	0.6
12	7.3	9.0	1.0	240	0.6
18	10.8	13.5	1.5	540	0.6
24	14.4	18.0	2.2	960	0.6

ORDERING INFORMATION

Type	HFKW /		012	1Z	W	-L	(XXX)
Coil voltage	006: 6VDC	009: 9VDC					
	010: 10VDC	012: 12VDC					
	018: 18VDC	024: 24VDC					
Contact arrangement	1H: 1 Form A		1Z: 1 Form C				
Contact material	W: AgSnO ₂		N: AgNi0.15				
Version	L: Reflow soldering version (open vent hole)			Nil: Wash tight			
Customer special code	e.g. (170) stands for flasher load						

OUTLINE DIMENSIONS, WIRING DIAGRAM AND PC BOARD LAYOUT

Unit: mm

Outline Dimensions

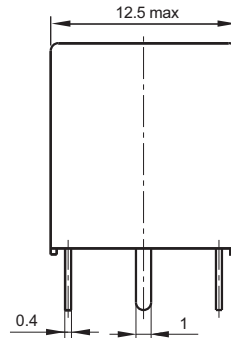
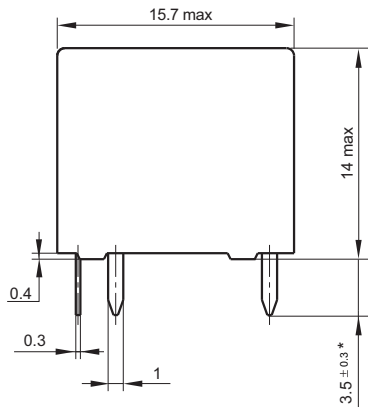

PCB Layout (Bottom view)

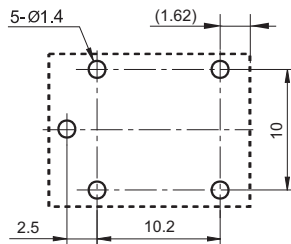

Wiring Diagram (Bottom view)

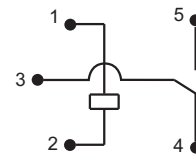

- Notes:**
- * The additional tin top is max. 1mm;
 - The terminal vertical deviation tolerance is 0.2mm;
 - In case of no tolerance shown in outline dimension: outline dimension $\leq 1\text{mm}$, tolerance should be $\pm 0.2\text{mm}$, outline dimension $> 1\text{mm}$ and $\leq 5\text{mm}$, tolerance should be $\pm 0.3\text{mm}$, outline dimension $> 5\text{mm}$, tolerance should be $\pm 0.4\text{mm}$;
 - The tolerance without indicating for PCB layout is always $\pm 0.1\text{mm}$.

CHARACTERISTIC CURVES

1. Coil operating voltage range

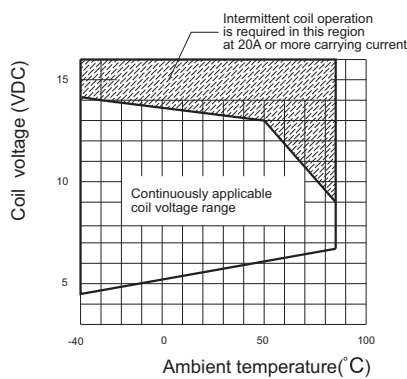

HFKW/009

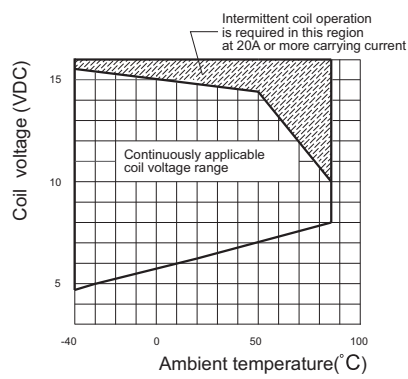

HFKW/010

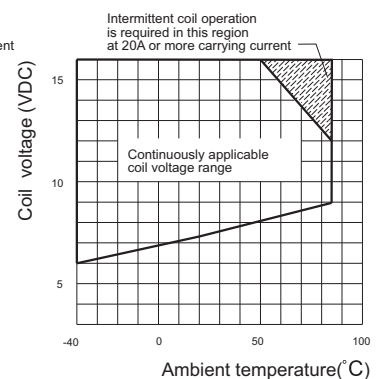

HFKW/012

CHARACTERISTIC CURVES

2. Load curve

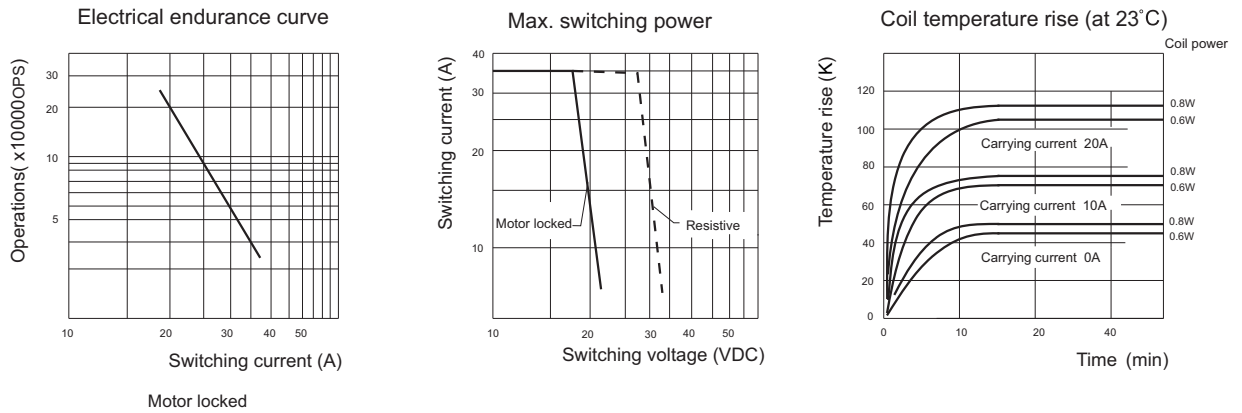

3. Vibration resistance characteristics

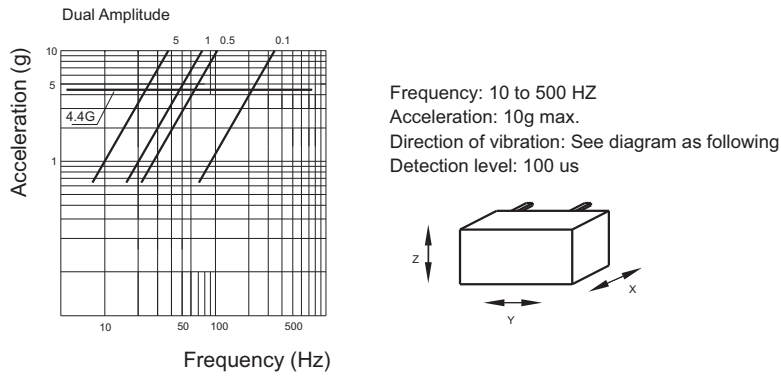

4. Shock resistance characteristics

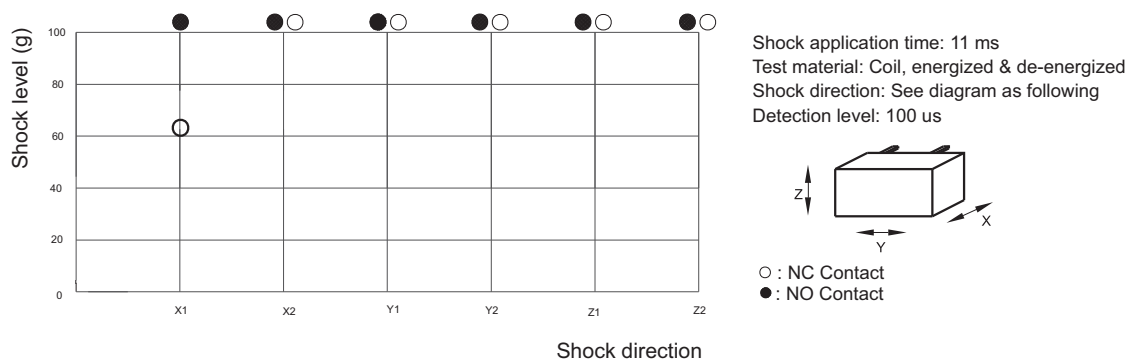

Disclaimer

This datasheet is for the customers' reference. All the specifications are subject to change without notice. We could not evaluate all the performance and all the parameters for every possible application. Thus the user should be in a right position to choose the suitable product for their own application. If there is any query, please contact Hongfa for the technical service. However, it is the user's responsibility to determine which product should be used only.